

Register your instrument!
www.eppendorf.com/myeppendorf



Centrifuge 5804/5804 R Centrifuge 5810/5810 R

Original Operating Instructions

Copyright © 2021 Eppendorf SE, Germany. All rights reserved, including graphics and images. No part of this publication may be reproduced without the prior permission of the copyright owner.

Corning® is a registered trademark of Corning Inc., USA.

Microtainer® is a registered trademark of Becton Dickinson, USA.

Eppendorf® and the Eppendorf Brand Design are registered trademarks of Eppendorf SE, Germany.

CombiSlide® is a registered trademark of Eppendorf SE, Germany.

QuickLock® is a registered trademark of Eppendorf SE, Germany.

Parasep® is a registered trademark of Apacor Ltd, UK.

Registered trademarks and protected trademarks are not marked in all cases with ® or ™ in this manual.

U.S. Design Patents are listed on www.eppendorf.com/ip

Table of contents

1	Operating instructions	7
1.1	Using this manual	7
1.2	Danger symbols and danger levels	7
1.2.1	Danger symbols	7
1.2.2	Danger levels	7
1.3	Symbols used	8
1.4	Abbreviations used	8
2	Safety	9
2.1	Intended use	9
2.2	User profile	9
2.3	Application limits	9
2.4	Warnings for intended use	10
2.4.1	Personal injury or damage to device	10
2.4.2	Incorrect handling of the centrifuge	12
2.4.3	Incorrect handling of the rotors	12
2.4.4	Extreme strain on the centrifugation tubes	14
2.5	Safety instructions on the device	15
3	Product description	17
3.1	Product overview	17
3.2	Delivery package	18
3.3	Features	19
3.4	Name plate	20
4	Installation	23
4.1	Selecting the location	23
4.2	Preparing installation	24
4.3	Installing the instrument	24
5	Operation	27
5.1	Operating controls	27
5.2	Preparing for centrifugation	28
5.2.1	Switching on the centrifuge	28
5.2.2	Inserting the rotor	28
5.2.3	Automatic rotor detection	29
5.2.4	Loading the rotor	30
5.2.5	Closing the centrifuge lid	34
5.3	Cooling (only 5804 R/5810 R)	34
5.3.1	Temperature adjustment	34
5.3.2	Temperature display	34
5.3.3	Temperature monitoring	35
5.3.4	FastTemp	35
5.3.5	Continuous cooling	36
5.4	Information on aerosol-tight centrifugation	37
5.4.1	Aerosol-tight centrifugation in a fixed-angle rotor	37

Table of contents

Centrifuge 5804/5804 R Centrifuge 5810/5810 R
English (EN)

5.5	Centrifuging	38
5.5.1	Centrifugation with time setting	38
5.5.2	Centrifuging in continuous operation	39
5.5.3	Short spin centrifugation	39
5.5.4	Removing the rotor	40
5.5.5	Standby mode	41
6	Operating controls and function	43
6.1	Setting the radius	43
6.2	Setting the acceleration and braking times	43
6.3	Setting the start of run time (At set rpm)	44
6.4	Saving the program	44
6.5	Loading the program	45
6.6	Deleting the program	45
6.7	Special functions	46
6.7.1	Display operating hours	46
6.7.2	Switching on/off the warning signal	46
6.7.3	Exiting the service functions	46
7	Maintenance	47
7.1	Service options	47
7.2	Service	47
7.3	Prepare cleaning/disinfection	47
7.4	Cleaning/disinfection	48
7.4.1	Cleaning and disinfecting the device	50
7.4.2	Cleaning and disinfecting the rotor	50
7.5	Additional care instructions for refrigerated centrifuges	51
7.6	Cleaning glass breakage	51
7.7	Decontamination before shipment	52
8	Troubleshooting	53
8.1	Resetting the excess current switch	53
8.2	General errors	53
8.3	Error messages	54
8.4	Emergency release	56
9	Transport, storage and disposal	57
9.1	Transport	57
9.2	Storage	57
9.3	Disposal	58
10	Technical data	59
10.1	Power supply	59
10.2	Ambient conditions	59
10.3	Weight/dimensions	60
10.3.1	Centrifuges	60
10.3.2	Rotor weights	61
10.4	Application parameters	62
10.5	Service life of accessories	64

10.6	Rotors	66
10.6.1	Rotor A-4-81 (only 5810/5810 R)	66
10.6.2	Rotor A-4-62 and A-4-62-MTP (only 5810/5810 R)	72
10.6.3	Rotor A-4-44	76
10.6.4	Rotor A-2-DWP-AT (only 5810/5810 R)	79
10.6.5	Rotor A-2-DWP	80
10.6.6	Rotor FA-45-6-30	82
10.6.7	Rotor F-34-6-38	84
10.6.8	Rotor FA-45-30-11 and F-45-30-11	86
10.6.9	Rotor F-45-48-PCR	87
10.6.10	Rotor T-60-11	87
10.6.11	Rotor S-4-104 (only 5810/5810 R)	88
10.6.12	Rotor S-4-72	95
10.6.13	Rotor F-35-48-17	97
10.6.14	Rotor FA-45-48-11	98
10.6.15	Rotor FA-45-20-17	99
11	Ordering Information	101
11.1	Rotors	101
11.1.1	Rotor A-4-81 (only 5810/5810 R)	101
11.1.2	Rotor A-4-62 and A-4-62-MTP (only 5810/5810 R)	103
11.1.3	Rotor A-4-44	104
11.1.4	Rotor A-2-DWP-AT (only 5810/5810 R)	105
11.1.5	Rotor A-2-DWP	106
11.1.6	Rotor FA-45-6-30	106
11.1.7	Rotor F-34-6-38	107
11.1.8	Rotor FA-45-30-11 and rotor F-45-30-11	107
11.1.9	Rotor F-45-48-PCR	108
11.1.10	Rotor T-60-11	108
11.1.11	Rotor S-4-104	108
11.1.12	Rotor S-4-72	110
11.1.13	Rotor F-35-48-17	110
11.1.14	Rotor FA-45-48-11	111
11.1.15	Rotor FA-45-20-17	111
11.2	Accessories	112
12	Annex	113
	Certificates	117

Table of contents

Centrifuge 5804/5804 R Centrifuge 5810/5810 R
English (EN)

1 Operating instructions







1.1 Using this manual

- ▶ Read this operating manual completely before using the device for the first time. Observe the instructions for use of the accessories where applicable.
- ▶ This operating manual is part of the product. Please keep it in a place that is easily accessible.
- ▶ Enclose this operating manual when transferring the device to third parties.
- ▶ The current version of the operating manual for all available languages can be found on our webpage www.eppendorf.com/manuals.

1.2 Danger symbols and danger levels

1.2.1 Danger symbols

The safety instructions in this manual have the following danger symbols and danger levels:

	Biohazard		Explosive substances
	Electric shock		Risk of crushing
	Hazard point		Material damage

1.2.2 Danger levels

DANGER	<i>Will</i> lead to severe injuries or death.
WARNING	<i>May</i> lead to severe injuries or death.
CAUTION	May lead to light to moderate injuries.
NOTICE	May lead to material damage.

Operating instructions

Centrifuge 5804/5804 R Centrifuge 5810/5810 R
English (EN)

1.3 Symbols used

Depiction	Meaning
1. 2.	Actions in the specified order
▶	Actions without a specified order
•	List
<i>Text</i>	Display or software texts
i	Additional information

1.4 Abbreviations used**MTP**

Microplate

PCR

Polymerase Chain Reaction

rcf

Relative centrifugal force : g -force in m/s^2

rpm

Revolutions per minute

UV

Ultraviolet radiation

2 Safety

2.1 Intended use

The Centrifuge 5804/5804 R/5810/5810 R is used for the separation of aqueous solutions and suspensions of different densities in approved sample tubes.

The Centrifuge 5804/5804 R/5810/5810 R is exclusively intended for use indoors. All country-specific safety requirements for operating electrical equipment in the laboratory must be observed.

2.2 User profile

The device and accessories may only be operated by trained and skilled personnel.

Before using the device, read the operating manual and the instructions for use of the accessories carefully and familiarize yourself with the device's mode of operation.

2.3 Application limits



DANGER! Risk of explosion.

- ▶ Do not use the device in an explosive atmosphere.
 - ▶ Do not operate the device in areas where work with explosive substances is carried out.
 - ▶ Do not use this device to process any explosive or highly reactive substances.
 - ▶ Do not use this device to process any substances which could create an explosive atmosphere.
-

Due to its design and the environmental conditions inside the device, the Centrifuge 5804/5804 R/5810/5810 R is not suitable for use in a potentially explosive atmosphere.

The device must be used only in a safe environment, such as in the open environment of a ventilated laboratory or a fume hood. The use of substances which could create a potentially explosive atmosphere is not permitted. It is the user's responsibility to make the final decision on the risks associated with the use of such substances.

2.4 Warnings for intended use

2.4.1 Personal injury or damage to device



WARNING! Electric shock due to damage to the device or mains/power cord.

- ▶ Only switch on the device if the device and mains/power cord are undamaged.
- ▶ Only operate devices that have been properly installed or repaired.
- ▶ In case of danger, disconnect the device from the mains/power supply.



WARNING! Lethal voltages inside the device.

Touching parts under high voltage can cause an electric shock. Electric shocks cause injuries to the heart and respiratory paralysis.

- ▶ Ensure that the housing is closed and undamaged.
 - ▶ Do not remove the housing.
 - ▶ Make sure that no liquids can enter the device.
- Only authorized service staff may open the device.



WARNING! Danger due to incorrect voltage supply.

- ▶ Only connect the device to voltage sources which correspond with the electrical requirements on the name plate.
- ▶ Only use earth/grounded sockets with a protective earth (PE) conductor.
- ▶ Only use mains/power cords that are approved for the technical data specified on the name plate and taking into account national laws and regulations. This also includes testing labels if required by law.



WARNING! Damage to health due to infectious liquids and pathogenic germs.

- ▶ When handling infectious liquids and pathogenic germs, observe the national regulations, the biosafety level of your laboratory, and the manufacturers' Safety Data Sheets and application notes.
- ▶ Use aerosol-tight locking systems for the centrifugation of these substances.
- ▶ When working with pathogenic germs which belong to a higher risk group, more than one aerosol-tight bioseal must be used.
- ▶ Wear your personal protective equipment.
- ▶ Consult the "Laboratory Biosafety Manual" (source: World Health Organization, Laboratory Biosafety Manual, as amended) for comprehensive regulations on the handling of germs or biological material of risk group II or higher.



WARNING! Risk of injury when opening or closing the centrifuge lid.

There is a risk of crushing your fingers when opening or closing the centrifuge lid.

- ▶ Do not reach between the device and centrifuge lid when opening or closing the centrifuge lid.
- ▶ Do not reach into the locking mechanism of the centrifuge lid.
- ▶ Open the centrifuge lid fully to ensure that the centrifuge lid cannot slam shut.



WARNING! Risk of injury due to defective gas spring(s).

A defective gas spring provides insufficient support for the centrifuge lid. There is a risk of crushing fingers or limbs.

- ▶ Make sure that the centrifuge lid can be opened fully and that it will remain in this position.
- ▶ Regularly check all gas springs for their proper function.
- ▶ Have defective gas springs replaced immediately.
- ▶ Have gas springs replaced by a service technician every 2 years.



WARNING! Risk of injury from rotating rotor.

If the emergency release of the lid is operated, the rotor may continue to rotate for several minutes.

- ▶ Wait for the rotor to stop before activating the emergency release.
- ▶ To check, look through the monitoring glass in the centrifuge lid.



WARNING! Risk of injury from chemically or mechanically damaged accessories.

Even minor scratches and cracks can lead to severe internal material damage.

- ▶ Protect all accessory parts from mechanical damage.
- ▶ Inspect the accessories for damage before each use. Replace any damaged accessories.
- ▶ Do not use rotors, rotor lids, buckets or caps showing any signs of corrosion or mechanical damage (e.g. deformations).
- ▶ Do not use any accessories which have exceeded their maximum service life.
- ▶ When inserting the buckets and rotors, ensure that they do not become scratched.



CAUTION! Poor safety due to incorrect accessories and spare parts.

The use of accessories and spare parts other than those recommended by Eppendorf may impair the safety, functioning and precision of the device. Eppendorf cannot be held liable or accept any liability for damage resulting from the use of accessories and spare parts other than those recommended or from improper use.

- ▶ Only use accessories and original spare parts recommended by Eppendorf.



NOTICE! Damage to the device due to spilled liquids.

1. Switch off the device.
2. Disconnect the device from the mains/power supply.
3. Carefully clean the device and the accessories in accordance with the cleaning and disinfection instructions in the operating manual.
4. If a different cleaning and disinfecting method is to be used, contact Eppendorf SE to ensure that the intended method will not damage the device.

Safety

Centrifuge 5804/5804 R Centrifuge 5810/5810 R
English (EN)

**NOTICE! Damage to electronic components due to condensation.**

Condensate may form in the device after it has been moved from a cool environment to a warmer environment.

- ▶ After installing the device, wait for at least 4 h. Only then connect the device to the mains/power line.

**NOTICE! Buckets swinging out in the wrong direction.**

If the wrong adapters are used for 500 mL Corning flasks, the buckets of the swing-bucket rotor may swing out in the wrong direction. If the buckets swing out in the wrong direction, this may lead to sample loss or damage to the centrifuge.

- ▶ Therefore, only use the Eppendorf adapter for 500 mL Corning flasks intended for this purpose.

2.4.2 Incorrect handling of the centrifuge

**NOTICE! Damage from knocking against or moving the device during operation.**

If the rotor hits the rotor chamber wall, it will cause considerable damage to the device and rotor.

- ▶ Do not move or knock against the device during operation.

2.4.3 Incorrect handling of the rotors

**WARNING! Risk of injury from improperly attached rotors and rotor lids.**

- ▶ Only centrifuge with the rotor and rotor lid firmly tightened.
- ▶ If any unusual noises occur when the centrifuge starts, the rotor or the rotor lid may not be attached properly. Stop the centrifugation immediately.

**CAUTION! Risk of injury due to asymmetric loading of a rotor.**

- ▶ Always load all positions of a swing-bucket rotor with buckets.
- ▶ Load buckets symmetrically with identical tubes or plates.
- ▶ Only load adapters with suitable tubes or plates.
- ▶ Always use tubes or plates of the same type (weight, material/density and volume).
- ▶ Use a balance to check that loading is symmetrical by balancing the adapters and tubes or plates that are used.



CAUTION! Risk of injury from overloaded rotor.

The centrifuge is designed for the centrifugation of material with a maximum density of 1.2 g/mL at maximum speed and filling volume and/or load.

- ▶ Do not exceed the maximum load of the rotor.



CAUTION! Risk of injury due to chemically damaged rotor lids or caps.

Transparent rotor lids or caps made from PC, PP or PEI may lose their strength under the impact of organic solvents (e.g. phenol, chloroform).

- ▶ If rotor lids or caps have come into contact with any organic solvents, they should be cleaned immediately.
- ▶ Regularly check the rotor lids and caps for damage and cracks.
- ▶ Replace any rotor lids or caps showing any cracks or milky discolorations immediately.



NOTICE! Damage to rotors from aggressive chemicals.

Rotors are high-quality assemblies designed to withstand extreme stresses. This stability can be impaired by aggressive chemicals.

- ▶ Avoid using aggressive chemicals such as strong and weak alkalis, strong acids, solutions with mercury ions, copper ions and other heavy metal ions, halogenated hydrocarbons, concentrated saline solutions and phenol.
- ▶ If it is contaminated by aggressive chemicals, clean the rotor and especially the rotor bores immediately using a neutral cleaning agent.
- ▶ Due to the manufacturing process, color variations may occur on PTFE coated rotors. These color variations do not affect the service life or resistance to chemicals.



NOTICE! If handled incorrectly, the rotor may fall.

The swing-bucket rotor may fall if the buckets are used as handles.

- ▶ Remove the buckets before inserting and/or removing a swing-bucket rotor.
- ▶ Always use both hands to carry the rotor cross.



NOTICE! If handled incorrectly, the rotor may fall.

- ▶ Always use both hands to pick up the F-35-48-17 rotor.
- ▶ In order to hold the rotor safely, you may have to remove 3 to 4 sleeves each from the outer rows opposite each other.

2.4.4 Extreme strain on the centrifugation tubes



CAUTION! Risk of injury from overloaded tubes.

- ▶ Note the loading limits specified by the tube manufacturer.
 - ▶ Only use tubes which are approved by the manufacturer for the required *g*-forces (rcf).
-



NOTICE! Danger from damaged tubes.

Damaged tubes must not be used, as this could cause further damage to the device and the accessories and loss of the samples.

- ▶ Visually check all tubes for damage before use.



NOTICE! Danger due to deformed or brittle material. Autoclaving at excessively high temperatures can lead to plastic tubes, adapters and rotor lids becoming brittle and deformed.

This could result in damage to the device and the accessories and sample loss.

- ▶ Observe the temperatures specified by the manufacturer when autoclaving tubes.
- ▶ Do not use any deformed or brittle tubes.



NOTICE! Danger from open tube lids.

Open tube lids may break off during centrifugation and damage both the rotor and the centrifuge.

- ▶ Carefully seal all tube lids before centrifuging.



NOTICE! Damage to plastic tubes due to organic solvents.

The density of plastic tubes is reduced when organic solvents (e.g. phenol, chloroform) are used, i.e. the tubes may become damaged.

- ▶ Note the manufacturer's information on the chemical resistance of the tubes.







NOTICE! Micro test tubes heat up.

In non-refrigerated centrifuges, the temperature in the rotor chamber, rotor and sample may increase to above 40 °C, depending on the run time, *g*-force (rcf)/speed and ambient temperature.

- ▶ Please note that this will reduce the centrifugation stability of the micro test tubes.
 - ▶ Please note the temperature resistance of the samples.
-

2.5 Safety instructions on the device

Symbol	Meaning	Location
	NOTICE ▶ Observe the safety instructions in the operating manual.	Right side of the device
	▶ Observe the operating manual.	
	▶ Warning: Possible hand injury	Upper side of the device
	Warning of biological risks when handling infectious liquids or pathogenic germs.	Aerosol-tight fixed-angle rotors: rotor lid Aerosol-tight buckets: cap

Safety

Centrifuge 5804/5804 R Centrifuge 5810/5810 R
English (EN)

3 Product description

3.1 Product overview

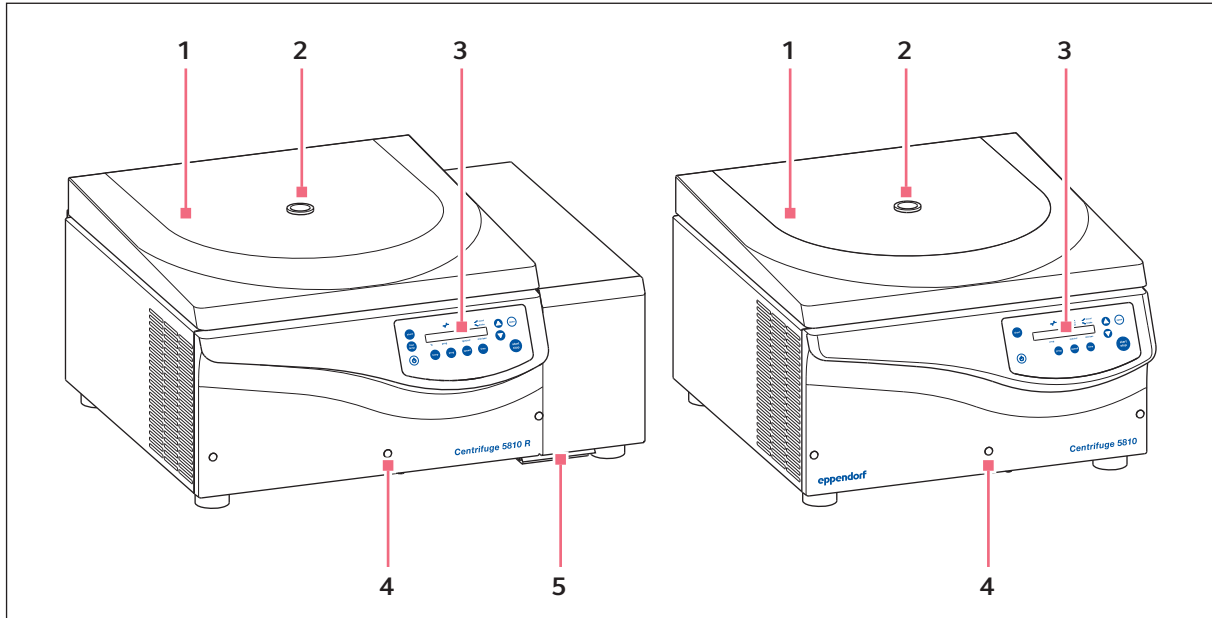


Fig. 3-1: Centrifuge 5810 R and Centrifuge 5810. Centrifuge 5804 R and Centrifuge 5804 are similar in design.

- | | |
|--|---|
| 1 Centrifuge lid | 4 Emergency release
(see <i>Emergency release</i> on p. 56) |
| 2 Monitoring glass
Visual control for rotor stop or option for speed check via stroboscope | 5 Condensation water tray (only Centrifuge 5804 R/5810 R) |
| 3 Operating controls and display
(see <i>Operating controls</i> on p. 27) | |

Product description

Centrifuge 5804/5804 R Centrifuge 5810/5810 R
English (EN)

3.2 Delivery package

1	Centrifuge 5804/5810
1	Rotor key
1	Mains/power cord
1	Operating manual
<hr/>	
1	Centrifuge 5804 R/5810 R
1	Rotor key
1	Mains/power cord
1	Operating manual
1	Condensation water tray



- ▶ Check whether the delivery is complete.
- ▶ Check all parts for transport damage.
- ▶ Keep the transport box and packing material in order to transport and store the device safely.

3.3 Features

The versatile centrifuge has a capacity of maximum 4 × 250 mL (Centrifuge 5804/5804 R) or 4 × 750 mL (Centrifuge 5810/5810 R) and reaches a maximum of 20913 × g/14000 rpm. The versatility is reflected in the available rotor options. You can select between 12 (Centrifuge 5804/5804 R) or 16 (Centrifuge 5810/5810 R) different rotors to centrifuge the following tubes for your various applications:

- Micro test tubes (0.2 mL to 5.0 mL)
- PCR strips
- Microtainers
- Spin columns
- Cryogenic tubes
- Conical tubes (15 mL/50 mL)
- Bottles (175 mL to 750 mL)
- Various tubes (3 mL to 120 mL)
- Microplates
- PCR plates
- Deepwell plates (max. height of 29 mm)
- Slides (with CombiSlide adapter)
- Cell-culture flasks

Handling the centrifuge is facilitated by:

- Low access height of 29 cm for loading and unloading the rotors
- Automatic rotor detection with rotational speed limit
- Automatic rotor imbalance detection
- Clear digital display

All centrifuges in these series have 35 program slots for user-defined settings and 10 different acceleration and braking ramps.

Adapter-specific manual radius adjustment guarantees maximum RCF accuracy.

The Centrifuge 5804 R/5810 R has an additional temperature control function for centrifugation between -9°C and 40°C. Use the **FastTemp** function to start a temperature control run without samples to adjust the rotor chamber incl. rotor, buckets and adapters quickly to the set temperature. Continuous cooling maintains the temperature after the run has been completed – your samples stay cool.

Product description

Centrifuge 5804/5804 R Centrifuge 5810/5810 R
English (EN)

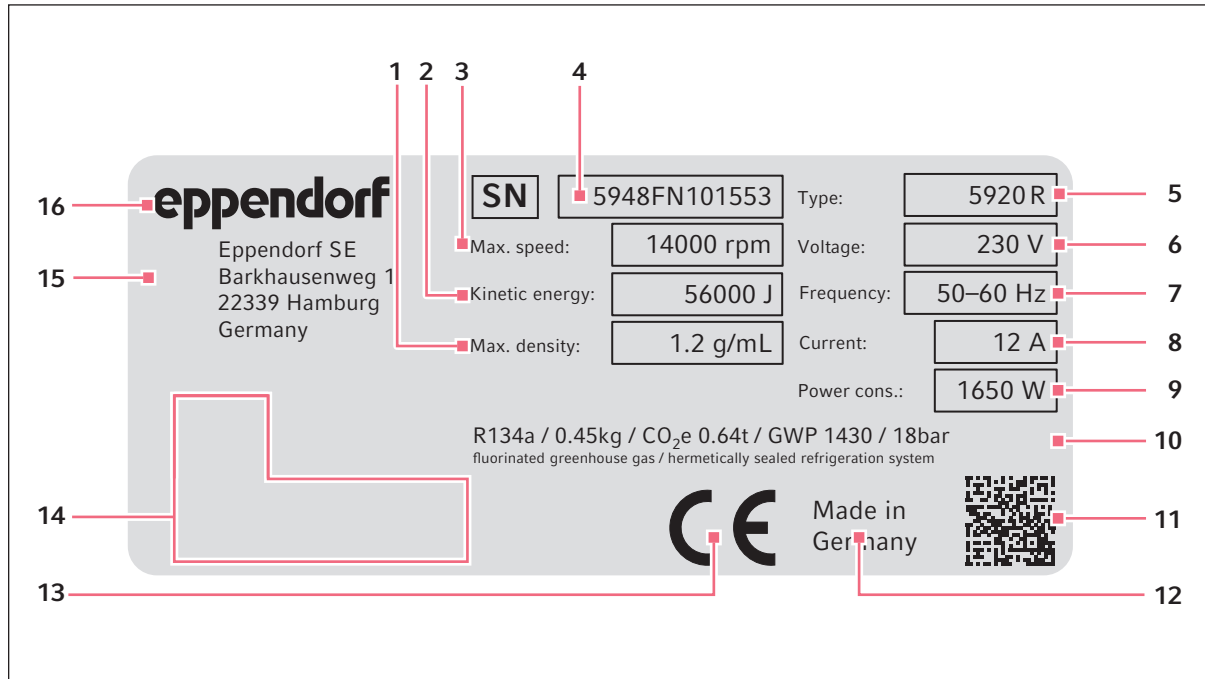





3.4 Name plate

Fig. 3-2: Device identification of Eppendorf SE (example)

- | | |
|---|--|
| 1 Maximum density of the material for centrifuging | 9 Maximum rated power |
| 2 Maximum kinetic energy | 10 Information on the refrigerant (refrigerated centrifuges only) |
| 3 Maximum speed | 11 Data matrix code for serial number |
| 4 Serial number | 12 Designation of origin |
| 5 Product name | 13 CE marking |
| 6 Rated voltage | 14 Certification marks and symbols (device-specific) |
| 7 Rated frequency | 15 Manufacturer's address |
| 8 Maximum rated current | 16 Manufacturer |

Tab. 3-1: Certification marks and symbols (device-specific)

Symbol/certification mark	Meaning
	Serial number
	Symbol for waste electrical and electronic equipment (WEEE) according to EU Directive 2012/19/EU, European Community
	UL listing certification mark: Declaration of conformity, USA
	Certification mark for electromagnetic compatibility of the <i>Federal Communications Commission</i> , USA
	Certification mark China – Use of certain hazardous substances in electrical and electronic products (<i>Requirements for Concentration Limits for Certain Hazardous Substances in Electronic Information Products SJ/T 11363-2006</i>), People’s Republic of China

Product description

Centrifuge 5804/5804 R Centrifuge 5810/5810 R
English (EN)

4 Installation

4.1 Selecting the location



WARNING! Danger due to incorrect voltage supply.

- ▶ Only connect the device to voltage sources which correspond with the electrical requirements on the name plate.
 - ▶ Only use earth/grounded sockets with a protective earth (PE) conductor.
 - ▶ Only use mains/power cords that are approved for the technical data specified on the name plate and taking into account national laws and regulations. This also includes testing labels if required by law.
-



NOTICE! If a fault occurs, any objects in the immediate proximity of the device will be damaged.

- ▶ In accordance with the recommendations of EN 61010-2-020, leave a safety clearance of **30 cm** around the device during operation.
- ▶ Please remove all materials and objects from this area.



NOTICE! Damage due to overheating.

- ▶ Do not install the device near heat sources (e.g., heating, drying cabinets).
- ▶ Do not expose the device to direct sunlight.
- ▶ Ensure unobstructed air circulation. Maintain a clearance of at least 30 cm around all ventilation gaps.



NOTICE! Radio interference.

For devices with Class A noise emission in accordance with DIN EN 61326-1:2013-07 and DIN EN 55011:2018-05, the following applies: This device has been developed and tested in accordance with CISPR 11 Class A. The device may cause radio interference in domestic environments and is not intended for use in residential areas. The device cannot ensure adequate protection of radio reception in residential areas and domestic environments.

- ▶ If necessary, take appropriate measure to eliminate the interferences.
-



Mains/power connection for centrifuges: Operation of the centrifuge is only permitted in building installations that comply with the applicable national regulations and standards. In particular, it must be ensured that there are no impermissible loads on the supply lines and assemblies that are located upstream of the internal protection of the device. This can be ensured by using additional circuit breakers or other suitable fuse elements in the building installation.



The mains/power switch and the disconnecting device for the mains/power line must be easily accessible during operation (e.g., a residual current circuit breaker).

Installation

Centrifuge 5804/5804 R Centrifuge 5810/5810 R
English (EN)

Select the location for the device according to the following criteria:

- Mains/power connection in accordance with the name plate
 - Minimum distance to other devices and walls: 30 cm
 - A resonance-free table with a horizontal, even work surface
 - The location has good ventilation.
 - The location is protected against direct sunlight.
- ▶ Do not use this device near strong electromagnetic sources (e.g., unshielded high frequency sources) as they could impair the proper operation of the device.

4.2 Preparing installation



CAUTION! Risk of injury due to lifting and carrying heavy loads

The device is heavy. Lifting and carrying the device can lead to back injuries.

- ▶ Transport and lift the device with an adequate number of helpers.
 - ▶ Use a transport aid for transporting the device.
-

Perform the following steps in the sequence described.

1. Open the box.
2. Remove the covering cardboard.
3. Remove the accessories.
4. Lift the device by the underside in the vicinity of the device feet and place it directly on a suitable lab bench.

4.3 Installing the instrument



WARNING! Danger due to incorrect voltage supply.

- ▶ Only connect the device to voltage sources which correspond with the electrical requirements on the name plate.
 - ▶ Only use earth/grounded sockets with a protective earth (PE) conductor.
 - ▶ Only use mains/power cords that are approved for the technical data specified on the name plate and taking into account national laws and regulations. This also includes testing labels if required by law.
-



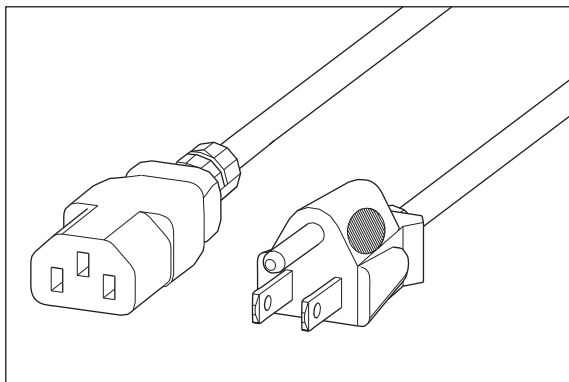
NOTICE! Centrifuge 5804 R/5810 R: Compressor damage after improper transport.

- ▶ After installation, wait 4 hours before switching on the centrifuge.
-

1. Allow the device to warm up for at least 3 hours (5804/5810) or 4 hours (5804 R/5810 R) to the ambient temperature to prevent damage to the electronic components from condensation and damage to the compressor (only 5804 R/5810 R).
2. Check that the mains/power supply voltage and mains/power frequency match the requirements on the name plate.
 Centrifuge 5804 R/5810 R with mains/power supply voltage 120 V: See also the notes on the mains/power supply at the end of this chapter.
3. Connect the centrifuge to the mains/power line and switch it on using the mains/power switch on the right side of the device.
 - The **open** key lights up.
 - The display is illuminated.
4. Open the centrifuge lid using the **open** key.
5. Use the information included in the delivery package to check that the delivery is complete.
6. Check all parts for any transport damage.
7. **Only 5804 R/5810 R:** Insert the condensation water tray at the front of the device into the provided holder.

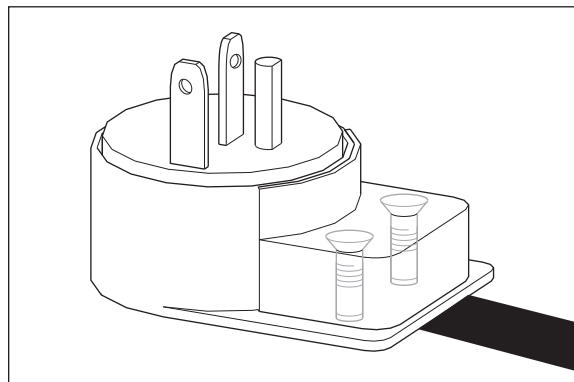
Tab. 4-1: Centrifuge 5804 R/5810 R with 120 V mains/power supply voltage in two versions

15 A IEC power cable



- Conventional IEC power cable.
- Connection to standard socket (120 V/15 A).
- Standard cooling performance:
 - Increased minimum achievable temperatures at maximum speed of centrifugation.
 - Slower cooling down to set temperature.

20 A version



- Mains/power cord fitted permanently to the device.
- Special mains/power connection required (120 V/20 A).
- Increased cooling performance.
 - Lower temperatures at maximum speed of centrifugation possible.
 - Quicker cooling down to set temperature.

Installation

Centrifuge 5804/5804 R Centrifuge 5810/5810 R
English (EN)

5 Operation

5.1 Operating controls

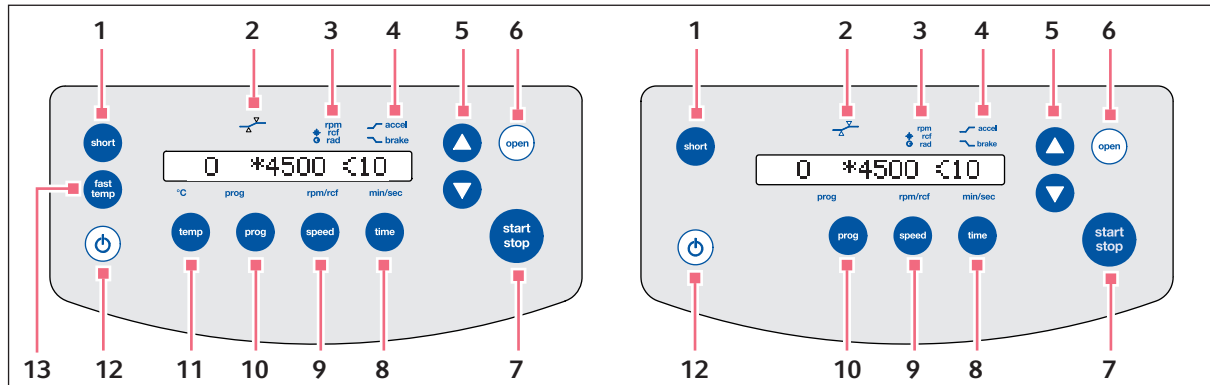


Fig. 5-1: Operating controls of the Centrifuge 5804 R/5810 R and the Centrifuge 5804/5810

- | | |
|--|--|
| <p>1 short key
Short run centrifugation</p> <p>2 Status of At set rpm function
 : Start of time counting when reaching 95% of the preset g force (rcf) or speed (rpm)
 : Start of time counting immediately.</p> <p>3 Indicate speed (rpm), g force (rcf) * and radius setting \odot.</p> <p>4 Symbol for acceleration and braking .</p> <p>5 Arrow keys
Set parameters and values
Keep the arrow key pressed: quick setting</p> <p>6 open key
Release lid</p> <p>7 start/stop key
Start or stop centrifugation</p> | <p>8 time key
Select runtime setting
Adjust the centrifugation time using the arrow keys</p> <p>9 speed key
Select the speed of centrifugation and adjust it using the arrow keys</p> <p>10 prog key
Press the prog key: Load program
Keep the prog key pressed for 2 s: Save current parameters</p> <p>11 temp key
Only 5804 R/5810 R: Select the temperature and adjust it using the arrow keys</p> <p>12 Standby key
LED lights green: centrifuge is operational
LED lights red: standby mode is active</p> <p>13 fast temp key
Start Only 5804 R/5810 R: temperature control run FastTemp</p> |
|--|--|

Operation

Centrifuge 5804/5804 R Centrifuge 5810/5810 R
English (EN)

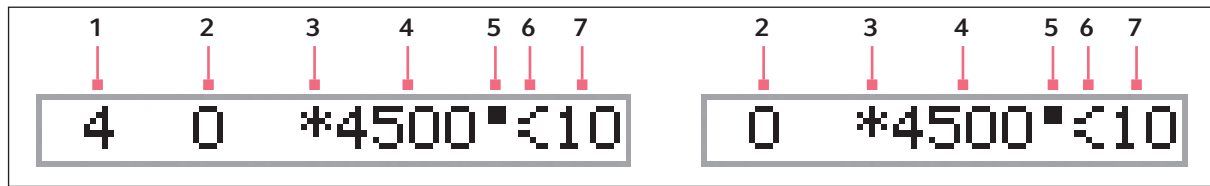


Fig. 5-2: Display of the Centrifuge 5804 R/5810 R and the Centrifuge 5804/5810

- | | |
|------------------------------------|--|
| 1 Only 5804 R/5810 R: temperature | 5 Symbol flashes during centrifugation |
| 2 Program number | 6 Symbol for acceleration ↗ and deceleration ↘ |
| 3 Symbol for <i>g</i> force (rcf) | 7 Centrifugation time |
| 4 <i>g</i> force (rcf)/speed (rpm) | |

Display of actual value and set value

- Rotor stop: display of set values
- Centrifugation: display of actual values

Display set value during centrifugation: press the **temp**, **time** or **speed** keys. The set value is displayed for 2.5 s.

5.2 Preparing for centrifugation**5.2.1 Switching on the centrifuge**

1. Switch on the centrifuge using the mains power switch or the Ⓞ standby key.
2. Open the closed centrifuge lid by pressing the **open** key.

The parameter settings of the last run are displayed.

5.2.2 Inserting the rotor**Prerequisites**

When attaching the rotor to or releasing it from the motor shaft, the temperature of the rotor and motor shaft must be within the range of 10 – 30°C.



NOTICE! If handled incorrectly, the rotor may fall.

- ▶ Always use both hands to pick up the F-35-48-17 rotor.
- ▶ In order to hold the rotor safely, you may have to remove 3 to 4 sleeves each from the outer rows opposite each other.



- ▶ **Swing-bucket rotors:** Remove the buckets before inserting and/or removing the rotor. Use both hands to pick up the rotor cross.

1. Place the rotor vertically onto the motor shaft.
2. Insert the supplied rotor key into the rotor nut.
Rotor cross A-4-81/S-4-104: use the special rotor key.
3. Turn the rotor key **clockwise** until the rotor nut is firmly tightened.

5.2.3 Automatic rotor detection

The centrifuge has automatic rotor detection. It detects a newly inserted rotor and displays its maximum permitted speed for approx. 2 s. g-force (rcf) and speed (rpm) are automatically limited to the maximum permitted value for the rotor.

In order to trigger the rotor detection,

- ▶ Start turning the rotor counterclockwise by hand and press the **start/stop** key.

The maximum permissible rotor speed is displayed. g-force (rcf) and speed (rpm) are automatically limited to the maximum permissible value for the rotor.



Rotor detection can also be triggered by short spin centrifugation:

- ▶ Press the short key until the maximum permitted speed for the rotor appears in the display.



If you start centrifuging immediately after a rotor change, the centrifuge has not carried out an automatic rotor detection yet. The speed set for the previous rotor may exceed the maximum permitted speed for the new rotor. In this case, the centrifuge stops after the automatic rotor detection and displays *SPEED*. The new maximum permissible speed is displayed.

Only select programs only after the automatic rotor detection.

You can then restart the centrifuging with these settings or adjust the speed as necessary.

- ▶ After each rotor change, check whether the new rotor is detected by the device.
- ▶ Check the set g-force (rcf) and/or speed (rpm) and adjust it if required.

5.2.4 Loading the rotor



CAUTION! Risk of injury due to asymmetric loading of a rotor.

- ▶ Always load all positions of a swing-bucket rotor with buckets.
- ▶ Load buckets symmetrically with identical tubes or plates.
- ▶ Only load adapters with suitable tubes or plates.
- ▶ Always use tubes or plates of the same type (weight, material/density and volume).
- ▶ Use a balance to check that loading is symmetrical by balancing the adapters and tubes or plates that are used.



CAUTION! Danger from damaged or overloaded tubes.

- ▶ When loading the rotor, observe the safety instructions for hazards resulting from overloaded or damaged tubes.



The device automatically detects imbalances during operation and stops the run immediately with an error message and a signal tone.

- ▶ Check the load, balance the tubes and restart the run.

5.2.4.1 Fixed-angle rotors

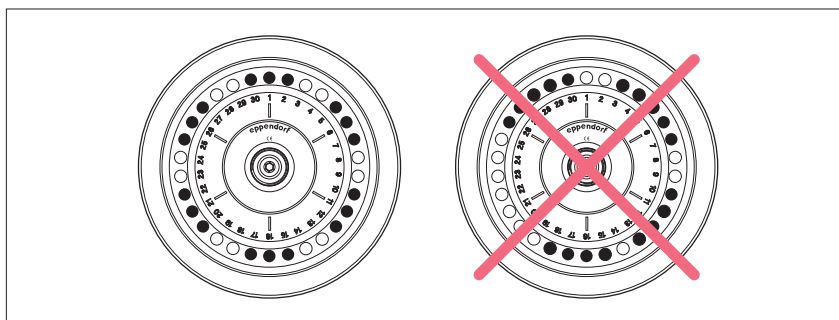


Rotor lid

- Fixed-angle rotors may only be operated with the appropriate rotor lid in each case. This is clearly shown by the identical rotor name labeling on the rotor and on the rotor lid.
- To carry out an aerosol-tight centrifugation, an aerosol-tight rotor must be used in combination with the corresponding rotor lid or cap.

To load the rotor, proceed as follows:

1. Check the maximum load (adapter, tube and contents) per rotor bore.
The information about this can be found on the rotor and in this operating manual (see *Rotors* on p. 66).
2. Load rotors and adapters only with the tubes intended for them.
3. Insert tubes opposite each other in pairs into the rotor bores. To ensure symmetrical loading, tubes that are arranged opposite each other must be of the same type and contain the same filling quantity.



To keep the weight differences between the filled sample tubes low, we recommend taring with a balance. This will reduce wear on the drive and cut operating noise.

4. Attach and tighten the rotor lid.

5.2.4.2 Swing-bucket rotors

Prerequisites

- A rotor, bucket and adapter combination approved by Eppendorf.
- Opposite buckets have the same weight category.
- The buckets are sorted by weight category. Buckets located opposite each other must belong to the same weight category. This is engraved in the groove on the side: e.g., 68 (the last 2 digits in grams). Please specify the corresponding weight category for reorders - including buckets.
- Matching and tested tubes and plates.
- Do not remove the middle guiding elements of the modular adapters of the rectangular buckets in order, e.g., to increase capacity through multi-level centrifugation.



NOTICE! Damage to adapters due to incorrect stacking.

- ▶ Stack the adapters in rectangular buckets in a closed row from the bottom of the bucket only. Do not leave any gaps between the modules.



NOTICE! Filling the plates too high can cause overflowing.

During the run the menisci in the tubes along the edges of the plates are at an angle. This is due to the centrifugal forces and cannot be avoided.

- ▶ Fill the plate wells to a maximum of 2/3 of the maximum filling volume.

To load the rotor, proceed as follows:

1. Make sure that the bucket grooves are clean and lightly grease them with pivot grease (int. order no.: 5810 350.050/North America: 022634330).
Dirty grooves and pivots prevent the buckets from swinging out evenly.
2. Hang the buckets into the rotor.
All rotor positions must be equipped with buckets.
3. Check to see if all buckets are completely hung and can freely swing out.
4. For rotor A-4-81, insert the adapters into the buckets such that the black sealing clamp points to the **Eppendorf** labeling on the bucket.

Ensuring free swinging of the buckets

5. To check whether bottles, plates or tubes can swing freely, swing buckets manually with empty tubes. The tubes must not come into contact with the rotor cross.

Checking the swinging direction

6. To check whether the buckets including their load swing with the bottom in the direction of the rotor chamber wall, start turning the rotor cross anti-clockwise.

Operation

Centrifuge 5804/5804 R Centrifuge 5810/5810 R
English (EN)

7. Check and observe the maximum load per bucket (adapter, tube or plate and contents) and the loading height.

The information about this can be found on the rotor and in this operating manual (see *Rotors on p. 66*).

8. Load the buckets symmetrically.

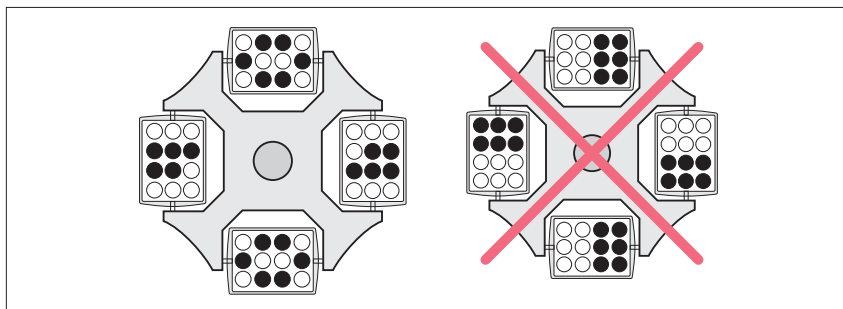


Fig. 5-3: Incomplete, but symmetrical loading of the buckets. All pivots of the rotor have to be evenly loaded.

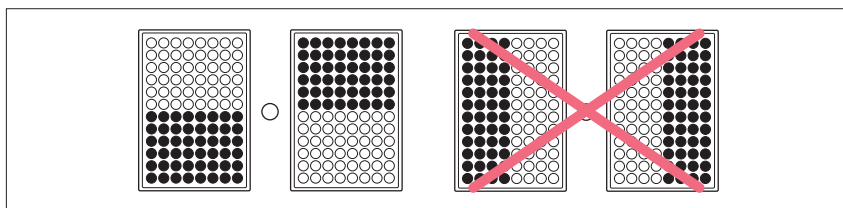


Fig. 5-4: Symmetrical loading of the plates.

The plate charging shown on the right-hand side is incorrect as the buckets will not swing out properly. The same principle also applies to the loading of rotor A-4-81-MTP/Flex with 4 plates. The plates have some play in the buckets.

9. Check the loading of the buckets.

5.2.4.3 Rotor S-4x750: Equipping the adapter with vessels > 119 mm



NOTICE! Broken glass due to incorrect equipping.

If the tubes in a bucket are too long, the swinging tubes will touch the rotor cross and may get damaged or destroyed.

- ▶ Equip buckets of swing-bucket rotors in such a way that they can swing out freely.
- ▶ If necessary, only equip the inner bores of the adapter.
- ▶ If using tubes longer than 100 mm: always perform a manual swing-out test.

If the adapter 16 × 75 mm – 100 mm (order number 5825 736.001) is equipped with vessels > 119 mm in length, e.g., BD 8 mL Vacutainer, there is a risk of glass breakage.

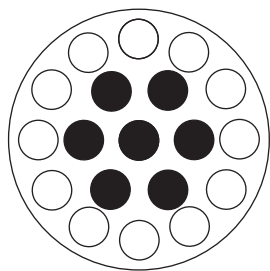


Fig. 5-5: Loading the adapter 16 x 75 - 100 mm with vessels >119 mm in length.

- ▶ Only load the inner bores.

5.2.4.4 Mixed loading with buckets

Mixed loading of swing-bucket rotors with buckets and plate buckets is possible if these are intended for the rotor. Buckets or plate buckets that are located opposite each other must be of the same type.

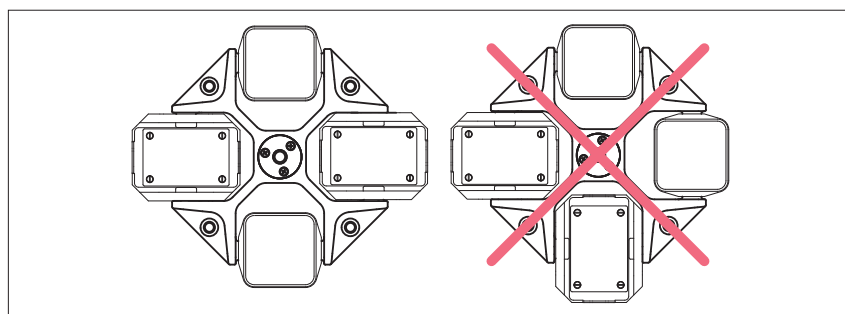


Fig. 5-6: Mixed loading of rotors

Rotor	Mixed equipping
S-4-104	<ul style="list-style-type: none"> • 2 buckets for plates (open buckets or plate buckets) • 2 round buckets
A-4-81/A-4-81-MTP/Flex	<ul style="list-style-type: none"> • 2 buckets (MTP or DWP buckets) • 2 buckets for conical tubes • 2 rectangular buckets
A-4-44	<ul style="list-style-type: none"> • 2 rectangular buckets • 2 buckets for conical tubes

Operation

Centrifuge 5804/5804 R Centrifuge 5810/5810 R
English (EN)



NOTICE! Rotor damage due to mixed loading.

If you load the rotors A-4-62 and A-4-62-MTP with a mixed equipment, the rotors are damaged during centrifugation.

- ▶ Load all positions of the A-4-62 and A-4-62-MTP rotors with the same buckets.
- ▶ Always load all 4 positions of the swing-bucket rotors.

- ▶ Check the loading of the buckets.

5.2.5 Closing the centrifuge lid



WARNING! Risk of injury when opening or closing the centrifuge lid.

There is a risk of crushing your fingers when opening or closing the centrifuge lid.

- ▶ Do not reach between the device and centrifuge lid when opening or closing the centrifuge lid.
- ▶ Do not reach into the locking mechanism of the centrifuge lid.
- ▶ Open the centrifuge lid fully to ensure that the centrifuge lid cannot slam shut.

1. Check the correct attachment of the rotor and rotor lid.
2. Push down the centrifuge lid until the lid latch engages and the lid is automatically closed.
The centrifuge will close automatically.
The **open** key lights up blue. ■ appears on the display.

5.3 Cooling (only 5804 R/5810 R)

5.3.1 Temperature adjustment

- ▶ Select the temperature setting using the **temp** key.
- ▶ Set the temperature using the arrow keys between -9°C and +40°C.

5.3.2 Temperature display

If the rotor is stopped:	Set temperature
During centrifugation:	Actual temperature

5.3.3 Temperature monitoring

After the set temperature has been reached, the centrifuge reacts to temperature deviations during centrifugation as follows:

Deviation from set value	Action
± 3 °C	Temperatures on the display are flashing.
± 5 °C	Periodic warning tone. Centrifugation is stopped automatically.

5.3.4 FastTemp

This function can be used to start a temperature control run directly without samples with a rotor and temperature-specific speed in order to quickly adjust the rotor chamber, including the rotor, buckets and adapters, to the previously set temperature.

Prerequisites

- The centrifuge is switched on.
- The rotor and rotor lid are attached properly.
- The centrifuge lid is closed.
- Temperature and g-force (rcf)/speed (rpm) for the centrifugation are set (see *Centrifuging on p. 38*).

1. Press the **fast temp** key.

The following appears on the display from left to right: Actual temperature value, *FT*, g-force (rcf)/speed (rpm) and -- (time).

The temperature control run ends automatically when the set temperature is reached. A periodic signal tone sounds.

2. Press the **start/stop** key to end the temperature control run early.

After the set temperature has been reached and the temperature control run is complete, the centrifuge keeps the rotor chamber with the centrifuge lid closed at the set target temperature if the temperature is below the ambient temperature. However, independent of the target temperature, 4 °C must be met via this continuous cooling in order to prevent the rotor chamber from freezing.



The centrifuge stops the cycle automatically if the rotor or the buckets have reached the set temperature. Therefore, there may be a delay of approx. 30 min between the display of the set temperature and the automatic end of the temperature control run.



When using aerosol-tight buckets, always carry out a FastTemp run at low temperatures without a cap. There is a danger otherwise of the caps becoming fixed by suction due to a vacuum. Do not pull on the sealing clamps or hooks to loosen the cap. Adjust the temperature of the buckets to room temperature so that the caps can be removed easily.

Operation

Centrifuge 5804/5804 R Centrifuge 5810/5810 R
English (EN)

5.3.5 Continuous cooling

If the rotor stops, the rotor chamber will be maintained at the target temperature if the following requirements have been met:

- The centrifuge is switched on.
- The centrifuge lid is closed.
- The set temperature is lower than the ambient temperature.
- The centrifuge is not in standby mode.

During continuous cooling the following applies:

- The set and actual temperature are displayed alternately.
- Irrespective of the set temperature, the temperature does not go below 4 °C to prevent the rotor chamber from freezing and from increased condensation in the device.
- The temperature adjustment takes longer because the rotor is not rotating.

To end continuous cooling, open the centrifuge lid or press the standby key.

If the centrifuge is not used for more than 8 hours, the continuous cooling is switched off automatically (ECO shut-off). The device then switches to standby mode. This protects against ice formation in the rotor chamber and increased condensation in the device. With **FastTemp** you can quickly reach the desired temperature again (see p. 35).

You can also change from automatically switching off continuous cooling after 8 hours (ECO shut-off) to unlimited continuous cooling.

**NOTICE! Ice formation and compressor overheating during continuous cooling.**

- ▶ Switch off the centrifuge regularly to eliminate any ice formation due to defrosting.
 - ▶ Regularly remove condensation water from the rotor chamber using a soft, absorbent cloth.
 - ▶ Empty and clean the condensation water tray regularly.
-

1. When the centrifuge lid is opened, press the **temp** and **prog** keys simultaneously.

Standby 8h appears in the display.

2. Press the **fast temp** key immediately.

Endless operation for continuous cooling is activated. *Standby endless* appears in the display.

3. To change back to *Standby 8h*, repeat the process.

5.4 Information on aerosol-tight centrifugation



WARNING! Damage to health due to limited aerosol tightness if an incorrect rotor/rotor lid combination is used.

Aerosol-tight centrifugation is only guaranteed if the rotors and rotor lids intended for this purpose are used. The designation of aerosol-tight fixed-angle rotors always starts with **FA**. The aerosol-tight rotors and rotor lids of this centrifuge are also marked with a red ring on the rotor and a red rotor lid screw.

Aerosol-tight swing-bucket rotors are marked with **AT** (aerosol-tight).

- ▶ Always use rotors and rotor lids marked as aerosol-tight together for aerosol-tight centrifugation. The details specifying in which centrifuge the aerosol-tight rotors and rotor lids may be used can be found on the rotor and on the top of the rotor lid.
- ▶ Only use aerosol-tight rotor lids in combination with the rotors indicated on the rotor lid.
- ▶ Only use aerosol-tight buckets with the corresponding caps.



WARNING! Damage to health due to limited aerosol tightness if used incorrectly.

Mechanical stresses and contamination by chemicals or other aggressive solvents may impair the aerosol tightness of the rotors and rotor lids. Autoclaving at excessively high temperatures can lead to plastic tubes, adapters and rotor lids becoming brittle and deformed.

- ▶ Check the integrity of the seals of the aerosol-tight rotor lids or caps before each use.
- ▶ Only use aerosol-tight rotor lids or caps if the seals are undamaged and clean.
- ▶ Do not exceed temperatures of 121 °C or a time of more than 20 min. when autoclaving.
- ▶ After each proper autoclaving process (121 °C, 20 min.), coat the threads of the rotor lid screw with a thin layer of pivot grease (order no. Int. 5810 350.050, North America 022634330).
- ▶ Replace aerosol-tight rotor lids without replaceable seals after 50 autoclaving cycles.
- ▶ On aerosol-tight rotor lids with exchangeable seals (e.g. QuickLock rotor lids) the seal only needs to be replaced after 50 autoclaving cycles.
- ▶ Replace aerosol-tight rotor caps after 50 autoclaving cycles.
- ▶ **Never** close aerosol-tight rotors or buckets for storage.



The aerosol tightness of rotors, rotor lids, buckets and caps has been tested and certified according to Annex AA of IEC 61010-2-020.

5.4.1 Aerosol-tight centrifugation in a fixed-angle rotor

To ensure aerosol tightness, the following applies:

- Replace aerosol-tight rotor lids without exchangeable seal and cap after 50 autoclaving cycles.
- Replace the seal of aerosol-tight rotor lids with exchangeable seal (e.g., QuickLock rotor lids) after 50 autoclaving cycles.
- Lightly grease the replaced seal with pivot grease after it is inserted.

5.5 Centrifuging



CAUTION! Danger due to incorrectly loaded rotors and damaged/overloaded tubes!

- ▶ Before commencing centrifugation, follow the safety instructions relating to risks from asymmetrically loaded and/or overloaded rotors and from overloaded, damaged and/or open tubes.








WARNING! Risk of injury from improperly attached rotors, rotor lids and caps.


- ▶ Only centrifuge if the rotor, the rotor lid, and inserted buckets are firmly tightened, and caps are closed correctly.
- ▶ If any unusual noises occur when the centrifuge starts, the rotor, the rotor lid or a cap may not be tightened properly. Stop centrifugation immediately by pressing the **start/stop** key.


Each of the centrifuging variants described here must be preceded by the preparation described above (see *Preparing for centrifugation on p. 28*).

5.5.1 Centrifugation with time setting

Perform the following steps in the sequence described.

-  1. Speed (rpm) setting: press once. g-force (rcf) setting: press repeatedly until the symbol * additionally appears in the display.
The displayed g-force (rcf)/speed (rpm) flashes and can be set with the arrow keys.
For the g-force (rcf) setting also check the set radius (see *Rotors on p. 66*), (see *Setting the radius on p. 43*).
-  2. Use the arrow keys to set the g-force (rcf)/speed (rpm).
The new set value appears in the display.
-  3. Select the runtime setting and set it with the arrow keys.
-  4. **Only 5804 R/5810 R:** Select the temperature setting and set it with the arrow keys.
-  5. Start centrifugation.
 - ■ blinks in the display when the rotor is running.
 - **Only 5804 R/5810 R:** The current temperature will be displayed.
 - The current g-force (rcf)/speed (rpm) of the rotor is displayed.
 - You can display all set values for 2.5 s by pressing a parameter key (**Temp, Speed, Time**).
 - You can terminate centrifugation early by pressing the **start/stop** key.
 - The centrifuge automatically stops after the set time has elapsed.
 - The elapsed centrifugation will be shown in a blinking display during the braking process.


-  6. Open the centrifuge lid as soon as the key lights up.


 During the run you can modify the total run time, the temperature (only Centrifuge 5804 R/ 5810 R) and the g-force (rcf)/speed (rpm) as well as the acceleration time and the braking time. The new parameters are adopted immediately. The time which has already elapsed is considered in the newly set total run time. Please note that the shortest new total run time that can be set is the elapsed time plus 2 minutes.


5.5.2 Centrifuging in continuous operation

Perform the following steps in the sequence described.


1. Set the g-force (rcf)/speed (rpm) and possibly the temperature as previously described (see p. 38).
2. Select the runtime setting.


3. Set continuous operation below 1 min or above 99 min.
 In the display ∞ indicates continuous run.



4. Start centrifugation.



 - ■ blinks in the display when the rotor is running.
 - If the centrifuge runs for more than 99 min, 99. appears in the display.
 - **Only 5804 R/5810 R:** The current temperature will be displayed.
 - The current g-force (rcf)/speed (rpm) of the rotor is displayed.
5. End centrifugation after the desired time.





 - The elapsed centrifugation will be shown in a blinking display during the braking process.
6. Open the centrifuge lid as soon as the key lights up.







5.5.3 Short spin centrifugation

You can carry out a short spin centrifugation with the currently set or with the maximum g-force (rcf)/ speed (rpm) of the used rotor.

5.5.3.1 Setting the speed option

- ▶  Press and hold down the key with the centrifuge lid open.
One of the following options appears in the display:
rpm max: the rotor accelerates up to its maximum g-force (rcf)/speed (rpm) (see *Rotors on p. 66*).
200 - rpm: the rotor only accelerates up to its set g-force (rcf)/speed (rpm).
- ▶  Press and hold down the key for more than 3 s with the centrifuge lid open to switch between the *rpm max* and *200 - rpm* options.
The selected option appears in the display for 2 s and is retained.

5.5.3.2 Starting the short spin centrifugation

1. If *200 - rpm* is set, set the g-force (rcf)/ speed (rpm) for the short spin centrifugation (see p. 38).
2. **Only 5804 R/5810 R:** set temperature (see p. 38).
3.  Keep the key pressed to start the short spin centrifugation.
 - *SH* appears in the display while the rotor is running.
 - The time is counted upwards in seconds.
4.  Release to end the short spin centrifugation.
5.  During the braking process, you can restart the centrifugation up to two times by pressing the **short** key again.
6.  Open the centrifuge lid as soon as the key is illuminated.

5.5.4 Removing the rotor

Prerequisites

When attaching the rotor to or releasing it from the motor shaft, the temperature of the rotor and motor shaft must be within the range of 10 – 30°C.



NOTICE! If handled incorrectly, the rotor may fall.

The swing-bucket rotor may fall if the buckets are used as handles.

- ▶ Remove the buckets before inserting and/or removing a swing-bucket rotor.
- ▶ Always use both hands to carry the rotor cross.



NOTICE! If handled incorrectly, the rotor may fall.

- ▶ Always use both hands to pick up the F-35-48-17 rotor.
 - ▶ In order to hold the rotor safely, you may have to remove 3 to 4 sleeves each from the outer rows opposite each other.
-

1. Turn the rotor nut **counterclockwise** using the rotor key.
2. Remove the rotor by lifting it vertically.
3. **Only 5804 R/5810 R:** Switch off the centrifuge after use and empty the condensation water tray. Leave centrifuge lid fully opened and protect it against closing.

5.5.5 Standby mode

- ▶ You can switch between standby mode and ready state at any time when centrifugation is not performed by pressing the standby key.

Standby mode

- The display expires.
- The standby key lights red.
- **Only 5804 R/5810 R:** The rotor chamber is not cooled (see *Continuous cooling on p. 36*).

Ready state

- The centrifugation parameters are displayed.
- The standby key lights up in green.
- **Only 5804 R/5810 R:** The rotor chamber is cooled when the centrifuge lid is closed (see *Continuous cooling on p. 36*).





Operation

Centrifuge 5804/5804 R Centrifuge 5810/5810 R
English (EN)

6 Operating controls and function







6.1 Setting the radius



When you control the rotational speed via the g -force (rcf, RCF), and not via the speed (rpm), the internal conversion of speed to g -force takes place by default with the largest radius of the used rotor. (see *Rotors on p. 66*). You can adapt this radius to an applied adapter:

-  1. Press several times until the  symbol also appears in the display.
The current radius flashes.
-  2. Set the new radius.
-  3. Wait for 3 seconds (if the rotor is stopped: 10 seconds).
The changed g -force appears.

6.2 Setting the acceleration and braking times

You can set the acceleration and braking time in the levels 0 to 9 (see Tab. on p. 63). Level 9 is preset (shortest acceleration and braking time).

-  1. Press twice until the  symbol for acceleration level (accel) appears in the display.
-  2. Select acceleration level 0 to 9.
-  3. Press once until the  symbol for braking level (brake) appears in the display.
-  4. Select braking level 0 to 9.
Braking level (brake) 0 corresponds to free deceleration.

The device only shows the  and  symbols continually when levels 0 to 8 have been set.

6.3 Setting the start of run time (At set rpm)

The centrifuge can count down the set time either immediately from the start of centrifugation or only once 95% of the specified g-force (rcf)/speed (rpm) has been reached (At set rpm). The respective setting is indicated by the flashing triangle in the symbol above the display:



Preset time: the set time is counted down immediately after the start of centrifugation.



At set rpm: the set time is counted down once 95% of the specified g-force (rcf)/speed (rpm) has been reached.

Prerequisites

The centrifuge lid is open.



- ▶ Hold down this key for at least 4 s to switch between the two settings,

When pressing the key, both triangles of the symbol will flash in turn.

6.4 Saving the program

You can save the current centrifugation parameters and functions (*At set rpm*, acceleration and braking times and radius) under up to 35 program numbers.

Prerequisites

Rotor stop.

1. Check the parameters and functions to be saved.
 2. Press key twice.
The first free program number appears with *P...* in the display.
 3. Select the program number (*1...9,A...Z*).
 4. Press and hold key for 2 seconds.
ok appears in the display. The current centrifugation parameters and functions are saved under the selected program number.
- i** When you want to overwrite a saved program, you have to delete it before saving the new parameters (see *Deleting the program on p. 45*).

6.5 Loading the program

Prerequisites

- Rotor stop.



1. Press once.
Program number flashes:
 - 0: centrifugation parameters and functions of the last run.
 - 1...9, A...Z: stored programs.



2. Select the program number.



3. Closed centrifuge lid: centrifugation starts with the loaded centrifugation parameters and functions.
When the centrifuge lid is open, you can press the **start/stop** key to return to program 0 or exit the programming mode.



If you change the centrifugation parameters during a run with a stored program, the centrifuge changes to program 0. The stored program remains unchanged.
You can also exit the stored program by loading program 0.

6.6 Deleting the program

Prerequisites

- Rotor stop.
- The centrifuge lid is open.



1. Press once.
The program number flashes.



2. Select the program number.



3. Within 10 seconds, keep key pressed for 2 seconds
The following text appears in the display: *cleared*.
The selected program is deleted. You can save new centrifugation parameters and functions under this program number.

Operating controls and function

Centrifuge 5804/5804 R Centrifuge 5810/5810 R
English (EN)

6.7 Special functions

6.7.1 Display operating hours

Prerequisite

Rotor stop.



▶ Press both keys simultaneously.

The previous total run time of the centrifuge (in hours) appears in the display.

6.7.2 Switching on/off the warning signal



▶ Press both keys simultaneously to change the setting.

Alarm on or *Alarm off* appears in the display after 2 s.

6.7.3 Exiting the service functions



▶ Press both keys simultaneously to exit a service function called by mistake.

7 Maintenance

7.1 Service options

Eppendorf recommends having your device checked and maintained by trained specialist personnel at regular intervals.

Eppendorf offers you tailor-made service solutions for the preventive maintenance, qualification and calibration of your device. For information, offers and contact options, please visit www.eppendorf.com/epservices.

7.2 Service



WARNING! Risk of injury due to defective gas spring(s).

A defective gas spring provides insufficient support for the centrifuge lid. There is a risk of crushing fingers or limbs.

- ▶ Make sure that the centrifuge lid can be opened fully and that it will remain in this position.
- ▶ Regularly check all gas springs for their proper function.
- ▶ Have defective gas springs replaced immediately.
- ▶ Have gas springs replaced by a service technician every 2 years.



WARNING! Risk of fire or electrical shock

- ▶ Have the centrifuge's electrical safety, especially the continuity of the protective connections, checked every 12 months by trained and skilled personnel.
-

7.3 Prepare cleaning/disinfection

- ▶ Clean all accessible surfaces of the device and the accessories at least weekly and when contaminated.
- ▶ Clean the rotor regularly. This way the rotor is protected and the durability is prolonged.
- ▶ Furthermore, observe the notes on decontamination (see *Decontamination before shipment on p. 52*) when the device is sent to the authorized Technical Service for repairs.

The procedure described in the following chapter applies to the cleaning as well as to the disinfection or decontamination. The table below describes the steps required on top of this:

Maintenance

Centrifuge 5804/5804 R Centrifuge 5810/5810 R
English (EN)

Cleaning	Disinfection/decontamination
<ol style="list-style-type: none"> 1. Use a mild cleaning fluid to clean the accessible surfaces of the device and the accessories. 2. Carry out the cleaning as described in the following chapter. 	<ol style="list-style-type: none"> 1. Choose the disinfection method which corresponds to the legal regulations and guidelines in place for your range of application. For example, use alcohol (ethanol, isopropanol) or alcohol-based disinfectants. 2. Carry out the disinfection or decontamination as described in the following chapter. 3. Then clean the device and the accessories.



If you have any further questions regarding cleaning and disinfection or decontamination or regarding the cleaning agents to be used, contact the Application Support of Eppendorf SE. The contact details are provided on the back of this manual.

7.4 Cleaning/disinfection



DANGER! Electric shock due to the ingress of liquid.

- ▶ Switch off the device and disconnect it from the mains/power line before commencing any cleaning or disinfection procedures.
- ▶ Do not allow any liquids to enter the inside of the housing.
- ▶ Do not spray clean or spray disinfect the housing.
- ▶ Do not reconnect the device to the mains/power line unless both the inside and outside of the device are completely dry.



NOTICE! Damage due to aggressive chemicals.

- ▶ Do not use any aggressive chemicals on the device or its accessories, such as strong and weak bases, strong acids, acetone, formaldehyde, halogenated hydrocarbons or phenol.
- ▶ If the device has been contaminated by aggressive chemicals, clean it immediately using a mild cleaning agent.



NOTICE! Corrosion due to aggressive cleaning agents and disinfectants.

- ▶ Do not use any corrosive cleaning agents, aggressive solvents or abrasive polishes.
- ▶ Do not incubate the accessories in aggressive cleaning agents or disinfectants for longer periods.



NOTICE! Damage from UV and other high-energy radiation.

- ▶ Do not use UV, beta or gamma rays, or any other high-energy forms of radiation for disinfection.
- ▶ Avoid storage in areas with high UV radiation.



NOTICE! Danger due to deformed or brittle tubes. Autoclaving at excessively high temperatures can lead to plastic vessels becoming brittle and deformed.

This could result in damage to the device and the accessories and sample loss.

- ▶ Observe the temperatures specified by the manufacturer when autoclaving tubes.
- ▶ Do not use any deformed or brittle tubes.



Autoclaving

Except for rotor crosses A-4-81, S-4-72 and S-4-104 and the Easyclean Adapter for A-4-44, all rotors, rotor lids, buckets, carriers, caps and adapters can be autoclaved (121 °C, 20 min). After a maximum of 50 autoclaving cycles, the caps and, for QuickLock rotors, the seals must be replaced.

Do not use seals that are stained, porous or defective in any other way. Also note the operating manual of the centrifuge and the leaflet on aerosol-tight centrifugation delivered together with the aerosol-tight rotors.

The aerosol-tight rotor FA-45-30-11 can be autoclaved at 142°C for 2 hours to destroy prions. Please note that in this case the rotor lid must be replaced after each autoclaving process.



Aerosol tightness

Check the integrity of the seals before each use.

Aerosol-tight rotor lids with a replaceable seal (e.g., QuickLock rotor lids) only: Replace the sealing ring in the lid groove when it becomes worn.

The seals of the rotor S-4-104 can be replaced.

Replace the rotor lids with screw cap when the sealing rings on the lid screw and in the lid groove become worn.

Regular care of the sealing rings is necessary in order to protect the rotors.

Never store aerosol-tight rotors with lids screwed on!

In order to prevent damage, lightly grease the lid threads of aerosol-tight rotors regularly with pivot grease (order no. int.: 5810 350.050/North America: 022634330).



The cap seals of rotors A-4-81, A-4-62, A-4-44 and A-2-DWP-AT cannot be replaced. If this is necessary, the caps will have to be replaced.



Swing-bucket rotors

- Before cleaning the rotor, remove old pivot grease from grooves and pegs.
- Make sure that the grooves and pegs are clean. Contaminated grooves and pegs prevent carriers from swinging out evenly.
- After cleaning, lightly lubricate the pegs of the rotor and the grooves of the buckets with pivot grease (order no. int.: 5810 350.050/North America: 022634330) so that the buckets can move freely in a swinging motion.

Maintenance

Centrifuge 5804/5804 R Centrifuge 5810/5810 R
English (EN)

7.4.1 Cleaning and disinfecting the device

1. Open the lid. Switch off the device using the mains/power switch. Disconnect the mains/power plug from the voltage supply.
2. Loosen the rotor nut by turning the rotor key **counterclockwise**.
3. Remove the rotor.
4. Clean and disinfect all accessible surfaces on the device including the mains/power cord using a damp cloth and the recommended cleaning agents.
5. Thoroughly clean the rubber seal of the rotor chamber with water.
6. Rub the dry rubber seal with glycerol or talcum powder to prevent it from becoming brittle. Other components of the device, such as the lid latch, lid springs, motor shaft and rotor cone, must not be lubricated.
7. Clean the motor shaft using a soft, dry, lint-free cloth. Do not grease the motor shaft.
8. Check the motor shaft for any damage.
9. Inspect the device for any corrosion and damage.
10. Leave the centrifuge lid open when the device is not in use.
11. Only reconnect the device to the mains/power supply if it is fully dry on the inside and on the outside.

7.4.2 Cleaning and disinfecting the rotor

After every 200 runs, the centrifuge displays *clean rotor* three times to remind you to clean the rotor regularly.


1. Inspect the rotor and accessories for any damage and corrosion. Do not use any damaged rotors or accessories.
2. Clean and disinfect the rotors and accessories using the recommended cleaning agents.
3. Use a bottle brush to clean and disinfect the rotor bores.
4. Rinse the rotors and accessories thoroughly with distilled water. Rinse the rotor bores of fixed-angle rotors particularly thoroughly.



Do not put the rotor into the dishwasher and do not immerse the rotor in liquid, as liquid may enter through the openings.

5. Place the rotors and accessories on a towel to dry. Place fixed-angle rotors with the rotor bores facing down so the bores can also dry.
6. Clean the rotor cone with a soft, dry, lint-free cloth. Do not lubricate the rotor cone.
7. Inspect the rotor cone for damage.
8. Place the dry rotor onto the motor shaft.
9. Tighten the rotor nut firmly by turning it **clockwise** with the rotor key.
10. Load the fixed-angle rotor with the cleaned adapters or the swing-bucket rotor with the cleaned buckets and adapters, if necessary.
11. Leave the rotor lid open when the rotor is not being used.

7.5 Additional care instructions for refrigerated centrifuges.

- ▶ Empty and clean the condensation water tray regularly and especially after liquid spillage in the rotor chamber. Pull out the condensation water tray front left under the device.
 - ▶ The condensation water outlet also needs to be cleaned on a regular basis, e.g. using a bottle brush.
 - ▶ Regularly defrost the rotor chamber for the refrigerated devices, either by leaving the centrifuge lid open or carrying out a brief temperature control run at approx. 30 °C.
 - ▶ To relieve the gas springs in the centrifuge lid, leave the centrifuge lid open when not in use for a long period.
Residual moisture can escape.
 - ▶ Wipe up condensation water in the rotor chamber. Use a soft absorbent cloth for this.
-  Leave the centrifuge lid open in order to allow the condensation water to evaporate.
- ▶ No later than every 6 months, remove any dust deposits from the ventilation gaps of the centrifuge using a brush or swab. First switch off the centrifuge and remove the mains/power plug.

7.6 Cleaning glass breakage

When using glass tubes there is a risk of glass breakage in the rotor chamber. The resulting glass splinters are swirled around in the rotor chamber during centrifugation and have a sandblasting effect on the rotor and accessories. The smallest glass particles become lodged in the rubber parts (e.g., the motor guide, the rotor chamber seal, and the rubber mats of adapters).



NOTICE! Glass breakage in the rotor chamber

Glass tubes in the rotor chamber may break if the g -force is too high. Broken glass can damage the rotor, accessories and samples.

- ▶ Please note the manufacturer's information on the recommended centrifugation parameters (load and speed).

Effects of glass breakage in the rotor chamber:

- Fine black metal abrasion in the rotor chamber (in metal rotor chambers)
- The surfaces of the rotor chamber and accessories are scratched.
- The chemical resistance of the rotor chamber is reduced.
- Contamination of samples
- Wear on rubber parts

How to proceed in case of glass breakage

1. Remove all splinters and glass powder from the rotor chamber and accessories.
2. Thoroughly clean the rotor and rotor chamber. Thoroughly clean the bores of the fixed-angle rotors, in particular.
3. If required, replace the rubber mats and adapters to prevent any further damage.
4. Regularly check the rotor bores for deposits and damage.

7.7 Decontamination before shipment

If you are shipping the device to the authorized Technical Service for repairs or to your authorized dealer for disposal please note the following:



WARNING! Risk to health from contaminated device.

1. Observe the information contained in the decontamination certificate. It is available as a PDF document on our webpage (<https://www.eppendorf.com/decontamination>).
 2. Decontaminate all parts to be shipped.
 3. Include the fully completed decontamination certificate in the shipment.
-

8 Troubleshooting

If you cannot remedy an error with the recommended measures, please contact your local Eppendorf partner. The contact address can be found on the Internet at www.eppendorf.com.

8.1 Resetting the excess current switch

Thermal excess current switches are mounted as fuses. If the excess current protection is triggered, they set the switch to OFF. However, they do not automatically switch it on again.

To switch on the excess current switch again, proceed as follows:

1. Switch off the centrifuge using the mains/power switch.
2. Wait for at least 20 s and switch on the centrifuge again.

The excess current switch is reactivated and the centrifuge is ready for operation.

8.2 General errors

Problem	Cause	Solution
No display.	No mains/power connection.	▶ Check the mains/power connection.
Display shows <i>Interrupt</i> after the centrifuge has been switched on.	Mains/power outage.	▶ Check the fuse of the centrifuge(see <i>Resetting the excess current switch on p. 53</i>). ▶ Check the mains/power fuse of the lab. ▶ Press the open key.
Centrifuge lid cannot be opened.	The rotor is still running.	▶ Wait for the rotor to stop.
	Mains/power outage.	1. Check the fuse of the centrifuge. 2. Check the mains/power fuse of the lab. 3. Activate the emergency lid release.
<i>Clean rotor</i>	200 runs.	▶ Clean the rotor and rotor chamber(see p. 47).
Centrifuge brakes during a short run centrifugation, although the short key is pressed.	The short key was released briefly more than twice (protective function for the drive).	▶ Press the short key continuously during a short run centrifugation. ▶ Briefly press the short key.

Troubleshooting

Centrifuge 5804/5804 R Centrifuge 5810/5810 R
English (EN)

8.3 Error messages

If one of the following error messages appears, proceed as follows:

1. Remove fault (see Solution).
2. Press the **open** key to clear the error message.
3. If necessary, repeat centrifugation.

Some errors can have various causes. The actual cause is described in the message in the device display.

Problem	Cause	Solution
<i>No rotor</i> Centrifuge does not start up.	No rotor.	▶ Insert the rotor.
<i>No rotor</i> Centrifuge does not start up.	Error in the drive or in the rotor detection.	▶ Switch the centrifuge off and back on again after > 20 s.
<i>Press Open</i>	Centrifuge lid could not be locked.	1. Press the open key. 2. Try to close the centrifuge lid again.
<i>Close lid</i>	Centrifuge lid not closed properly.	▶ Close the centrifuge lid firmly.
<i>Lift lid</i> The centrifuge lid does not open.	The centrifuge lid cannot open automatically.	▶ Lift the centrifuge lid manually.
<i>IMBAL</i> The centrifuge shakes when it starts up and then switches off.	The rotor is loaded asymmetrically.	▶ Load the rotor symmetrically(see p. 28).
<i>ROTOR</i> The centrifuge shakes when it starts up and then switches off.	The rotor is not screwed sufficiently tight.	1. Tighten the rotor nut(see p. 28). 2. Check the rotor cone and motor shaft for grooves and damage.
<i>ROTOR</i> The centrifuge shakes when it starts up and then switches off.	<ul style="list-style-type: none"> • Centrifuge was pushed. • Table is not stable. 	▶ Position the centrifuge on a stable table(see p. 23).
<i>SPEED</i> Centrifuge switches off.	Nominal speed too high for rotor.	▶ Enter the appropriate nominal speed(see p. 66).

Problem	Cause	Solution
<i>change rotor</i>	The maximum service life of the rotor has been reached. The warning is displayed after 98,000, 99,000 and 99,600 runs (3 times after each run). After 100,000 runs, it is displayed after every run.	▶ Contact Technical Service.
Temperature display flashes. (only 5804 R/ 5810 R)	Temperature deviation from set value: ± 3 °C.	▶ Check the settings. ▶ Wait until the set temperature has been reached. ▶ Check unhindered air circulation through the air slots. ▶ Thaw ice or switch off the centrifuge and allow it to cool down.
<i>Overtemp</i> (only 5804 R/ 5810 R) Centrifuge switches off and issues a warning tone.	Temperature deviation from set value in the rotor chamber: ± 5 °C.	▶ Check the settings. ▶ Check unhindered air circulation through the air slots. ▶ Thaw ice or switch off the centrifuge and allow it to cool down.
<i>Clear Memory</i>	Program memory full.	▶ Delete some programs(see p. 45).
<i>Interrupt</i>	Mains/power failure during a run.	▶ Check the mains/power connection.
<i>Error 1</i>	Error in the rotational speed measurement system.	▶ If this error message appears again, test with a different rotor.
<i>Error 2</i>	Imbalance sensor faulty.	▶ Repeat the run.
<i>Error 3</i>	Error in the rotational speed measurement system.	▶ Insert and tighten rotor.
<i>Error 3</i>	Error in the rotational speed measurement system.	▶ Allow the centrifuge to stand for 12 min when switched on until the open key lights up.
<i>Error 4</i>	Lid latch sensor faulty.	▶ Switch the centrifuge off and back on again after > 20 s.
<i>Error 5</i>	Prohibited opening of lid or lid switch is defective during a run.	1. Wait for the rotor to stop. 2. Open the centrifuge lid and then close it again. 3. Repeat the run.
<i>Error 6 or overload</i>	Mains/power supply voltage is too low.	▶ Check the mains/power supply voltage.
	<ul style="list-style-type: none"> • Frequency converter overloaded. • Brake faulty. 	▶ Switch off centrifuge, allow to cool down for at least 5 min, and then switch on again.
<i>Error 8</i>	<ul style="list-style-type: none"> • Drive fault. • Rotor loose. • Motor defective. 	1. Wait for the rotor to stop. 2. Tighten the rotor. 3. Repeat the run.

Troubleshooting

Centrifuge 5804/5804 R Centrifuge 5810/5810 R
English (EN)

Problem	Cause	Solution
<i>Error 9 to Error 25</i>	Electronics fault.	▶ Switch the centrifuge off and back on again after > 20 s.

8.4 Emergency release

If the centrifuge lid cannot be opened, you can activate the emergency release manually.



WARNING! Risk of injury from rotating rotor.

If the emergency release of the lid is operated, the rotor may continue to rotate for several minutes.

- ▶ Wait for the rotor to stop before activating the emergency release.
- ▶ To check, look through the monitoring glass in the centrifuge lid.

You need the standard rotor key supplied with the centrifuge.

1. Disconnect the power plug.
2. Remove the plastic cover for the emergency release. This is located in the center on the front side of the device.
3. Insert the rotor key into the hexagonal opening behind until some resistance can be felt.
4. While keeping the rotor key pressed, turn it in a counterclockwise direction.
This will release the centrifuge lid.
5. Open the centrifuge lid.
6. Remove the rotor key and put the plastic covers back on.

9 Transport, storage and disposal

9.1 Transport



CAUTION! Risk of injury due to lifting and carrying heavy loads

The device is heavy. Lifting and carrying the device can lead to back injuries.

- ▶ Transport and lift the device with an adequate number of helpers.
- ▶ Use a transport aid for transporting the device.

- ▶ Remove the rotor from the centrifuge before transport.
- ▶ Use the original packaging and the transport securing devices for transport.

	Air temperature	Relative humidity	Atmospheric pressure
General transport	-25 °C – 60 °C	10 % – 75 %	30 kPa – 106 kPa
Air freight	-20 °C – 55 °C	10 % – 75 %	30 kPa – 106 kPa

9.2 Storage

	Air temperature	Relative humidity	Atmospheric pressure
In transport packing	-25 °C – 55 °C	10 % – 75 %	70 kPa – 106 kPa
Without transport packing	-5 °C – 45 °C	10 % – 75 %	70 kPa – 106 kPa

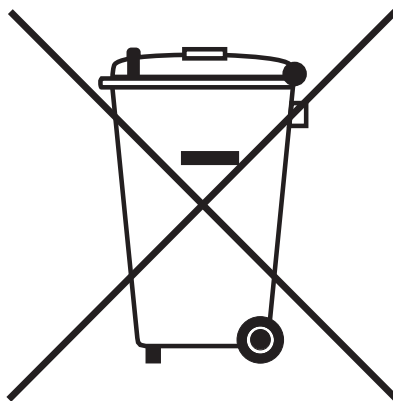
9.3 Disposal

Observe the relevant legal regulations when disposing of the product.

Information on the disposal of electrical and electronic devices in the European Community:

Within the European Community, the disposal of electrical devices is regulated by national regulations based on EU Directive 2012/19/EU pertaining to waste electrical and electronic equipment (WEEE).

According to these regulations, any devices supplied after August 13, 2005, in the business-to-business sphere, to which this product is assigned, may no longer be disposed of in municipal or domestic waste. They are marked with the following symbol to indicate this:



As the disposal regulations may differ from one country to another within the EU, please contact your supplier for more information.

10 Technical data

10.1 Power supply

Mains/power connection	230 V, 50 – 60 Hz 120 V, 50 – 60 Hz	
Current consumption	5804/5810 (230 V): 6 A 5804/5810 (120 V): 11 A 5804 R/5810 R (230 V): 9 A/10 A 5804 R/5810 R (120 V, 20 A): 16 A 5804 R/5810 R (120 V, 15 A): 12 A	
Power consumption	5804/5810 (230 V): max. 900 W 5804/5810 (120 V): max. 950 W 5804 R/5810 R (230 V): max. 1650 W 5804 R/5810 R (120 V, 20 A): max. 1650 W 5804 R/5810 R (120 V, 15 A): max. 1300 W	
EMC: noise emission (radio interference)	5804/5810 (230 V): EN 61326-1 – Class A 5804/5810 (120 V): CFR 47 FCC Part 15 – Class A 5804/5810 (100 V): EN 61326-1 – Class A 5804 R/5810 R (230 V): EN 61326-1/EN 55011 – Class A 5804 R/5810 R (120 V): CFR 47 FCC Part 15 – Class A 5804 R/5810 R (100 V): EN 61326-1/EN 55011 – Class A	
EMC: noise immunity	EN 61326-1	
Overvoltage category	II	
Fuses	5804/5810 (230 V) 5804/5810 (120 V) 5804 R/5810 R (230 V) 5804 R/5810 R (120 V, 20 A) 5804 R/5810 R (120 V, 15 A)	Excess current switch 12 A Excess current switch 12 A Excess current switch 12 A Excess current switch 18 A Excess current switch 15 A

10.2 Ambient conditions

Environment	For indoor use only The surroundings must not be moist.	
Ambient temperature	5804	4 °C – 35 °C
	5810	4 °C – 40 °C
	5804 R, 5810 R	10 °C – 35 °C
Max. relative humidity	75 %, non-condensing humidity	
Atmospheric pressure	75 kPa – 106 kPa Use up to an altitude of 2000 m above MSL	
Pollution degree	2	

Technical data

Centrifuge 5804/5804 R Centrifuge 5810/5810 R
English (EN)

10.3 Weight/dimensions**10.3.1 Centrifuges**

Dimensions (W × D × H)	5804	466 × 550 × 337 mm Depth of footprint: 496 mm
	5804 R	634 × 550 × 342 mm Depth of footprint: 496 mm
	5810	535 × 608 × 345 mm Depth of footprint: 536 mm
	5810 R	700 × 608 × 345 mm Depth of footprint: 536 mm
Weight without rotor	5804	55 kg
	5804 R	80 kg
	5810	68 kg
	5810 R	99 kg

		Rotor				
		A-4-81 (4 × 500 mL)	A-4-44 (4 × 100 mL)	F-34-6-38 (6 × 85 mL)	S-4-104	FA-45-6-30
Noise level	5804	–	< 65 dB(A)	< 51 dB (A)	–	< 55 dB(A)
	5804 R	–	< 56 dB(A)	< 58 dB(A)	–	< 54 dB(A)
	5810	< 65 dB(A)	< 65 dB(A)	< 53 dB(A)	< 70 dB(A)	< 56 dB(A)
	5810 R	< 56 dB(A)	< 56 dB(A)	< 59 dB(A)	< 56 dB(A)	< 55 dB(A)

The noise level was measured according to DIN EN ISO 3745 frontally in a sound measuring room with accuracy class 1 at a distance of 1 m from the device and at lab bench height.

10.3.2 Rotor weights

Rotor	Accessories	Weight [g]
S-4-104		5220
	Bucket	575
	DWP bucket	790
A-4-81		5400
	Bucket	585
	Flex bucket	810
	Form bucket 7x50	880
A-4-62		2900
	Bucket	460
	MTP bucket	730
S-4-72		3100
	Bucket	290
A-4-44		1600
	Bucket	290
	Form bucket	420
A-2-DWP-AT		5250
	Bucket	970
A-2-DWP		2000
	MTP bucket	630
F-34-6-38		3220
FA-45-6-30		3300
FA-45-48-11		2400
FA-45-30-11		1300
F-45-30-11		900
FA-45-20-17		2800
F-35-48-17		2100
	Sleeve	30
T-60-11		2100
F-45-48-PCR		1000

Technical data

Centrifuge 5804/5804 R Centrifuge 5810/5810 R
English (EN)

10.4 Application parameters

Run time	1 – 99 min, adjustable in 1 min increments. infinite (∞)	
Temperature (only 5804 R/5810 R)	-9 °C – 40 °C	
Relative centrifugal force (RCF)	10 – 20913 × g, adjustable to 3000 × g in 10 × g increments, then in increments of 100 × g.	
Speed	200 – 14000 rpm, adjustable up to 5000 rpm in 10 rpm increments, then in increments of 100 rpm.	
Max. load	5804/5804 R 5810/5810 R	4 × 250 mL 4 × 750 mL
Max. kinetic energy	5804/5810 5804 R 5810 R	19000 J (11000 rpm) 19000 J (11000 rpm) 23000 J (12100 rpm)
Inspection obligation in Germany	Yes	
Permitted density of the material for centrifuging (at max. g-force/ rotational speed and max. load)	1.2 g/mL	
Standardized interface (optional)	RS 232 C	

All rotors of the Centrifuge 5804 R/5810 R maintain a temperature of 4 °C ±2 °C safety at maximum speed. An exceptions are rotors F-34-6-38 and FA-45-6-30 on the Centrifuge 5810 R:

Tab. 10-1: Influence of speed on the temperature

Centrifuge	Rotor	Temperature at max. speed	Speed for safe maintenance of 4 °C ±2 °C
5810 R 120 V	F-34-6-38	< 11 °C	10000 rpm
	FA-45-6-30	< 12 °C	10500 rpm
5810 R 230 V	F-34-6-38	< 9 °C	11000 rpm
	FA-45-6-30	< 10 °C	11000 rpm

Temperature accuracy at maximum speed under the following conditions:

- pre-cooled
- after 45 min. run time
- set to 4 °C

Acceleration and deceleration times (according to DIN 58970)

Tab. 10-2: Approximate acceleration times of the different rotors for the levels 0 to 9 (in seconds) for 230 V devices

5804/ 5804 R	5810/5810 R	Rotor	0	1	2	3	4	5	6	7	8	9
-	•	A-4-81	227	198	173	149	132	111	97	85	60	35
-	•	A-4-81- MTP/ Flex	223	195	170	147	129	109	95	83	59	33
-	•	A-4-62	222	195	170	148	129	110	96	85	59	27
•	•	A-4-44	373	299	257	215	190	142	106	75	45	20
-	•	A-2-DWP-AT	256	223	191	167	147	126	111	98	72	45
•	•	A-2-DWP	203	176	133	117	100	78	61	45	36	18
•	•	FA-45-6-30	468	378	285	203	179	156	136	103	78	47
•	•	F-34-6-38	467	376	282	199	176	153	132	99	74	36
•	•	F-45-30-11/ FA-45-48-11	282	143	96	73	59	50	44	37	33	19
•	•	F-45-48-PCR	244	123	83	63	51	43	38	32	28	14
•	•	T-60-11	284	145	99	77	63	55	49	43	39	28
-	•	S-4-104 (round bucket)	217	189	166	144	126	108	84	58	43	35
-	•	S-4-104 (plate bucket)	217	189	165	142	125	107	82	55	41	33
•	•	S-4-72	304	247	209	175	154	115	56	29	18	14
•	•	F-35-48-17	704	330	277	233	206	152	72	38	23	17

Tab. 10-3: Approximate deceleration times of the different rotors for the levels 0 to 9 (in seconds) for 230 V devices

5804/ 5804 R	5810/5810 R	Rotor	0	1	2	3	4	5	6	7	8	9
-	•	A-4-81	466	203	178	154	137	118	95	86	57	31
-	•	A-4-81- MTP/ Flex	513	201	176	154	135	115	94	85	57	30
-	•	A-4-62	477	199	175	151	133	114	95	86	57	26
•	•	A-4-44	282	288	230	201	178	138	90	69	47	21
-	•	A-2-DWP-AT	611	227	197	172	153	130	108	97	66	34
•	•	A-2-DWP	274	182	140	122	105	83	57	45	34	14
•	•	FA-45-6-30	113 9	392	296	216	190	167	131	98	80	53
•	•	F-34-6-38	735	385	290	210	184	161	130	97	80	48

Technical data

Centrifuge 5804/5804 R Centrifuge 5810/5810 R
English (EN)

5804/ 5804 R	5810/5810 R	Rotor	0	1	2	3	4	5	6	7	8	9
•	•	F-45-30-11/ FA-45-48-11	317	148	77	54	42	36	27	23	20	18
•	•	F-45-48-PCR	171	128	69	47	36	31	23	20	17	15
•	•	T-60-11	638	295	153	107	85	69	50	43	40	35
-	•	S-4-104 (round bucket)	690	196	173	152	133	114	70	49	38	32
-	•	S-4-104 (plate bucket)	621	196	170	149	131	114	69	48	37	32
•	•	S-4-72	337	242	196	172	152	119	55	32	21	17
•	•	F-35-48-17	310	287	248	214	189	143	73	41	27	16

These values are to be considered as guidelines. Level 9 means "strongest braking", level 0 means "free deceleration". Considerable fluctuations can occur depending upon the condition of the device and the load. The deceleration times for the 230 and 120 V devices are almost identical.

10.5 Service life of accessories



WARNING! Risk of injury from chemically or mechanically damaged accessories.

Even minor scratches and cracks can lead to severe internal material damage.

- ▶ Protect all accessory parts from mechanical damage.
- ▶ Inspect the accessories for damage before each use. Replace any damaged accessories.
- ▶ Do not use rotors, rotor lids, buckets or caps showing any signs of corrosion or mechanical damage (e.g. deformations).
- ▶ Do not use any accessories which have exceeded their maximum service life.
- ▶ When inserting the buckets and rotors, ensure that they do not become scratched.



CAUTION! Risk of injury due to chemically damaged rotor lids or caps.

Transparent rotor lids or caps made from PC, PP or PEI may lose their strength under the impact of organic solvents (e.g. phenol, chloroform).

- ▶ If rotor lids or caps have come into contact with any organic solvents, they should be cleaned immediately.
- ▶ Regularly check the rotor lids and caps for damage and cracks.
- ▶ Replace any rotor lids or caps showing any cracks or milky discolorations immediately.

Eppendorf states the maximum service life of rotors and accessories in cycles and years. The number of cycles is decisive. If determination of the number of cycles is not possible, the service life in years applies.

Each centrifugation run during which the rotor is accelerated and braked is counted as a cycle, independent of the speed and the duration of the centrifugation run.

Rotor	Maximum service life after initial setup	
A-2-DWP-AT	100000 cycles	15 years
A-2-DWP	34000 cycles	7 years
A-4-44	34000 cycles	7 years
A-4-62	40000 cycles	7 years
A-4-81	100000 cycles	15 years
F-34-6-38	75000 cycles	10 years
FA-45-6-30	100000 cycles	15 years
FA-45-48-11	100000 cycles	15 years
FA-45-20-17	100000 cycles	15 years
F-35-48-17	100000 cycles	15 years
S-4-72	100000 cycles	15 years
S-4-104	100000 cycles	15 years
T-60-11	n/a	7 years

Unless stated otherwise (in the manual of the centrifuge, indication of the number of cycles on the rotor, in the instructions for use of the rotor), all other rotors and rotor lids can be used over the entire service life of the centrifuge if the following prerequisites are met:

- proper use
- recommended maintenance
- undamaged condition

Accessories	Maximum service life after initial setup	
Rotor lid of polycarbonate (PC), polypropylene (PP) or polyetherimide (PEI)	–	3 years
Aerosol-tight rotor lid, without replaceable seals	50 autoclaving cycles	–
QuickLock rotor lid		3 years
Seals of the QuickLock rotor lids	50 autoclaving cycles	–
Caps of polycarbonate (PC), polypropylene (PP) or polyetherimide (PEI)	50 autoclaving cycles	3 years
Adapter	–	1 year

The date of manufacture is stamped on the rotors and buckets in the format *03/15* or *03/2015* (= March 2015). On the inside of the plastic-rotor lids and aerosol-tight caps, the date of manufacture is stamped in the form of a clock ⌚.

Measures to ensure aerosol tightness:

- ▶ Replace the seal of QuickLock rotor lids after 50 autoclaving cycles.
- ▶ Exchange aerosol-tight rotor lids without replaceable seals after 50 autoclaving cycles.
- ▶ Replace aerosol-tight caps after 50 autoclaving cycles.

Technical data

Centrifuge 5804/5804 R Centrifuge 5810/5810 R
English (EN)

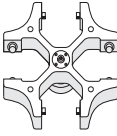


10.6 Rotors



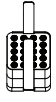






Eppendorf centrifuges may only be operated with rotors that are intended for use with the corresponding centrifuge.

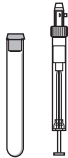
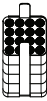












- ▶ Only use rotors that are marked with the name of the centrifuge (e.g., 5804 R).

The Centrifuge 5804/5804 R/5810/5810 R can be operated with the following rotors. When using sample tubes, observe the manufacturers' information regarding centrifugation stability (max. g-force).

10.6.1 Rotor A-4-81 (only 5810/5810 R)**10.6.1.1 Rotor A-4-81 with 500 mL rectangular bucket**


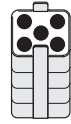

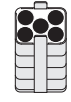




			Max. g-force: 3220 × g
			Max. speed: 4000 rpm
Rotor A-4-81	Rectangular bucket 500 mL	Aerosol-tight cap	Max. load per bucket (adapter, tube and contents): 780 g

	Tube	Adapter	Bottom shape	Max. g-force
	Capacity		Tube diameter	Max. speed
	Tubes per adapter/rotor	Order no. (international)	Max. tube length with/without cap	Radius
	Micro test tube 1.5/2 mL 20/80	 5810 745.004	Flat Ø 11 mm 43 mm/43 mm	2950 × g 4000 rpm 16.5 cm
	Blood collection tube 1.2 mL – 5 mL 20/80	 5810 746.000	Flat Ø 11 mm 108 mm/108 mm	3000 × g 4000 rpm 16.8 cm
	Tube 2.6 mL – 5 mL 25/100	 5810 720.001	Flat Ø 13 mm 107 mm/108 mm	3000 × g 4000 rpm 16.8 cm
	Tube 2.6 mL – 7 mL 18/72	 5810 747.007	Flat Ø 13 mm 108 mm/108 mm	3000 × g 4000 rpm 16.8 cm

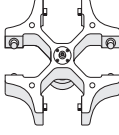
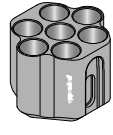
Tube	Tube	Adapter	Bottom shape	Max. <i>g</i> -force
	Capacity		Tube diameter	Max. speed
	Tubes per adapter/ rotor	Order no. (international)	Max. tube length with/without cap	Radius
	Blood collection tube 3 mL – 15 mL 16/64	 5810 748.003	Flat Ø 16 mm 108 mm/108 mm	3000 × <i>g</i> 4000 rpm 16.8 cm
	Tube 7 mL – 17 mL 16/64	 5810 721.008	Flat Ø 17.5 mm 118 mm/118 mm	3000 × <i>g</i> 4000 rpm 16.8 cm
	Conical tube 15 mL 12/48	 5810 722.004	Conical Ø 17.5 mm 121 mm/121 mm	3100 × <i>g</i> 4000 rpm 17.3 cm
	Conical tube 25 mL 5/20	 5810 723.000 Top adapter module removed	Conical Ø 29.8 mm 78.5 mm/78.5 mm	2647 × <i>g</i> 4000 rpm 14.8 cm
	Conical tube 25 mL 5/20	 5810 723.000 Top adapter module removed	Conical Ø 29.8 mm 83 mm/83 mm	2826 × <i>g</i> 4000 rpm 15.8 cm
	Conical tube 50 mL 5/20	 5810 723.000	Conical Ø 30 mm 116 mm/122 mm	3100 × <i>g</i> 4000 rpm 17.3 cm
	Conical tube 50 mL 5/20	 5810 723.000	Conical Ø 30 mm -/118 mm	3100 × <i>g</i> 4000 rpm 17.3 cm




Technical data

Centrifuge 5804/5804 R Centrifuge 5810/5810 R
English (EN)

Tube	Tube	Adapter	Bottom shape	Max. <i>g</i> -force
	Capacity		Tube diameter	Max. speed
	Tubes per adapter/ rotor	Order no. (international)	Max. tube length with/without cap	Radius
	Midi Parasep (R) 5/20	 5810 723.000	Conical Ø 30 mm 116/122 mm	3100 × <i>g</i> 4000 rpm 17.3 cm
	Conical tube, skirted 50 mL 5/20	 5810 739.004  5804 737.008	Flat Ø 31 mm -/119 mm	3100 × <i>g</i> 4000 rpm 17.3 cm
	Bottles 180 mL – 250 mL 1/4	 5825 722.000 The manufacturer's adapter is required for conical bottles	Flat Ø 62 mm -/133 mm	3100 × <i>g</i> 4000 rpm 17.3 cm
	Wide-neck bottle, rectangular 500 mL -/4	–	Flat 83 mm 134 mm/134 mm	3220 × <i>g</i> 4000 rpm 18.0 cm

10.6.1.2 Rotor A-4-81 with conical tubes

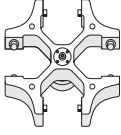
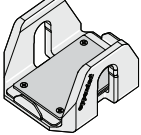
		Max. <i>g</i> -force:	3220 × <i>g</i>
		Max. speed:	4000 rpm
Rotor A-4-81	Bucket for 7 × 50 mL conical tubes	Max. load per bucket (adapter, tube and contents):	7 × 75 g

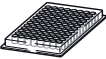
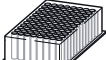
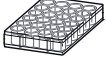



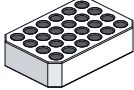

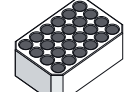

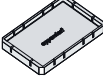
Tube	Tube	Adapter	Bottom shape	Max. <i>g</i> -force
	Capacity		Tube diameter	Max. speed
	Tubes per adapter/rotor	Order no. (international)	Max. tube length	Radius
	Conical tube 15 mL 7/28	 5820 718.005	Conical Ø 17.5 mm 120 mm	3184 × <i>g</i> 4000 rpm 17.8 cm
	Conical tube 50 mL 7/28	—	Conical Ø 30 mm 117 mm	3220 × <i>g</i> 4000 rpm 18.0 cm

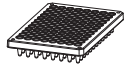
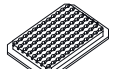
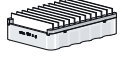

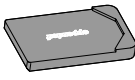
Technical data

Centrifuge 5804/5804 R Centrifuge 5810/5810 R
English (EN)

10.6.1.3 Rotor A-4-81 with MTP/Flex bucket

		Max. <i>g</i> -force:	2900 × <i>g</i>
		Max. speed:	4000 rpm
Rotor A-4-81	MTP/Flex bucket	Max. load per bucket (adapter, plate and contents):	380 g

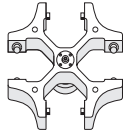
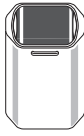

	Plate	Adapter	Bottom shape	Max. <i>g</i> -force
	Capacity		Tube diameter	Max. speed
	Number per adapter/rotor	Order no. (international)	Max. loading height	Radius
	Microplate 96/384 wells 4/16	–	Flat – 60 mm	2900 × <i>g</i> 4000 rpm 16.3 cm
	Deepwell plate 96 wells 1/4	–	Flat – 60 mm	2900 × <i>g</i> 4000 rpm 16.3 cm
	Cell-culture plate 2/8	–	Flat – 60 mm	2900 × <i>g</i> 4000 rpm 16.3 cm
	Kit 1/4	–	Flat – 60 mm	2900 × <i>g</i> 4000 rpm 16.3 cm
	IsoRack 24 × 0.5 mL micro test tubes 1/4	 5825 708.008	Flat Ø 6 mm 60 mm	2700 × <i>g</i> 4000 rpm 15.0 cm
	IsoRack 24 × 1.5/2 mL micro test tubes 1/4	 5825 709.004	Flat Ø 11 mm 60 mm	2600 × <i>g</i> 4000 rpm 14.6 cm
	PCR plate 384 wells 1/4	 5825 713.001	Flat – 60 mm	2700 × <i>g</i> 4000 rpm 15.8 cm











Tube	Plate	Adapter	Bottom shape	Max. g-force
	Capacity		Tube diameter	Max. speed
	Number per adapter/rotor	Order no. (international)	Max. loading height	Radius
	PCR plate 96 wells 1/4	 5825 711.009	Flat – 60 mm	2600 × g 4000 rpm 16.1 cm
Slide	CombiSlide 12 slides 12/48	 5825 706.005	Flat – 60 mm	1000 × g 2372 rpm 15.9 cm
	Cell culture bottle with/without filter 25 cm ² : Sarstedt 83.1810.002/ 83.1810 Greiner Bio-One 690175/690160 TPP 90026/90025 IWAKI 3102-025 1/4	 5825 719.000	Flat – 60 mm	1000 × g 2501 rpm 14.3 cm















Technical data

Centrifuge 5804/5804 R Centrifuge 5810/5810 R
English (EN)

10.6.2 Rotor A-4-62 and A-4-62-MTP (only 5810/5810 R)**10.6.2.1 Rotor A-4-62 with 250 mL rectangular bucket**















			Max. <i>g</i> -force: 3,220 × <i>g</i>
Rotor A-4-62	Rectangular bucket 250 mL	Aerosol-tight cap	Max. speed: 4,000 rpm
Swing-bucket rotor with 4 × 250 mL rectangular buckets			Max. load per bucket (adapter, tube and contents): 620 g

Tube	Tube Capacity Tubes per adapter/rotor	Adapter Order no. (international)	Adapter bottom shape Tube diameter Max. tube length with/without aerosol-tight bucket cap	Max. <i>g</i>-force Max. speed Centrifugation radius
	Micro test tube 1.5/2 mL 16/64	 5810 751.004	Flat Ø 11 mm 43 mm/43 mm	3,000 × <i>g</i> 4,000 rpm 17.1 cm
	Tubes 1.2 to 5 mL 25/100	 5810 750.008	Flat Ø 11 mm 115 mm/123 mm	3,050 × <i>g</i> 4,000 rpm 17.3 cm
	Tubes 2.6 to 7 mL 15/60	 5810 752.000	Flat Ø 13 mm 118 mm/121 mm	3,050 × <i>g</i> 4,000 rpm 17.3 cm
	Tubes 3 to 15 mL 12/48	 5810 753.007	Flat Ø 16 mm 116 mm/121 mm	3,050 × <i>g</i> 4,000 rpm 17.3 cm
	Tubes 7 to 17 mL 12/48	 5810 754.003	Flat Ø 17.5 mm 114 mm/118 mm	3,050 × <i>g</i> 4,000 rpm 17.3 cm

Tube	Tube Capacity Tubes per adapter/rotor	Adapter Order no. (international)	Adapter bottom shape Tube diameter Max. tube length with/ without aerosol-tight bucket cap	Max. g-force Max. speed Centrifugation radius
	Conical tube 15 mL 9/36	 5810 755.000	Conical Ø 17.5 mm 121 mm/127 mm	3,150 × g 4,000 rpm 17.8 cm
	7 to 18 mL 12/48 8/32	 5810 756.006	Flat Ø 20 mm 119 mm/126 mm	3,050 × g 4,000 rpm 17.3 cm
	Tube 18 to 30 mL 4/16	 5810 757.002	Flat Ø 26 mm 116 mm/119 mm	3,050 × g 4,000 rpm 17.3 cm
	Conical tube 25 mL 3/12	 5810 758.009 Top adapter module removed	Conical Ø 29.8 mm 80 mm/85 mm	3,184 × g 4,000 rpm 17.8 cm
	Conical tube 25 mL 3/12	 5810 758.009 Top adapter module removed	Conical Ø 29.8 mm 91 mm/91 mm	3,184 × g 4,000 rpm 17.8 cm
	Conical tube 50 mL 3/12	 5810 758.009	Conical Ø 30 mm 116 mm/122 mm	3,094 × g 4,000 rpm 17.8 cm
	Conical tube 50 mL 3/12	 5810 758.009	Conical Ø 30 mm -/118 mm	3,094 × g 4,000 rpm 17.8 cm

Technical data

Centrifuge 5804/5804 R Centrifuge 5810/5810 R
English (EN)

Tube	Tube Capacity Tubes per adapter/rotor	Adapter Order no. (international)	Adapter bottom shape Tube diameter Max. tube length with/ without aerosol-tight bucket cap	Max. g-force Max. speed Centrifugation radius
	Conical tube 50 mL 4/16	 5810 763.002  5804 728.009 (blue)	Flat Ø 30 mm -/122 mm	3,094 × <i>g</i> 4,000 rpm 17.3 cm
	Tube 30 to 50 mL 4/16	 5810 759.005	Flat Ø 30 mm 113/115 mm	3,050 × <i>g</i> 4,000 rpm 17.3 cm
	Conical tube, skirted 50 mL 4/16	 5810 759.005  5804 737.008 (white)	Flat Ø 30 mm 113/115 mm	3,050 × <i>g</i> 4,000 rpm 17.3 cm
	Tube 50 to 75 mL 2/8	 5810 760.003	Flat Ø 35 mm 118/122 mm	3,050 × <i>g</i> 4,000 rpm 17.3 cm
	Tube 80 to 120 mL 1/4	 5810 761.000	Flat Ø 45 mm 125/138 mm	3,050 × <i>g</i> 4,000 rpm 17.3 cm
	Bottles 180 to 250 mL 1/4	 5810 770.009 The manufacturer's adapter is required for conical bottles	Flat Ø 62 mm 127/136 mm	3,220 × <i>g</i> 4,000 rpm 18.0 cm

10.6.2.2 Rotor A-4-62 with MTP bucket

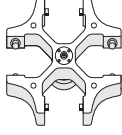
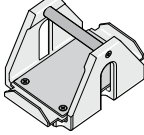
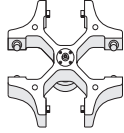
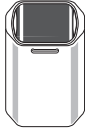







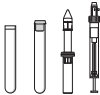


















		Max. g-force: $2,750 \times g$
Rotor A-4-62 Swing-bucket rotor with 4 MTP buckets	MTP buckets	Max. speed: 4,000 rpm
		Max. load per bucket 380 g (adapter, plate and contents)

Plate	Plate Capacity Plates or glass slides per adapter/rotor	Adapter Order no. (international)	Bottom shape Max. loading height	Max. g-force Max. speed Centrifugation radius
	Microplate 96/384 wells 4/16		Flat 53 mm	$2,750 \times g$ 4,000 rpm 15.4 cm
	Deepwell plate 96/384 wells 1/4		Flat 53 mm	$2,750 \times g$ 4,000 rpm 15.4 cm
	Cell-culture plate 2/8		Flat 53 mm	$2,750 \times g$ 4,000 rpm 15.4 cm
	384-well PCR plate 1/4	 5825 713.001	Flat 53 mm	$2,700 \times g$ 4,000 rpm 14.9 cm
	96-well PCR plate 1/4	 5825 711.009	Flat 53 mm	$2,600 \times g$ 4,000 rpm 15.2 cm
Slide	CombiSlide 12 slides 12/48	 5825 706.005	Flat 53 mm	$1,000 \times g$ 2,442 rpm 15.0 cm

Technical dataCentrifuge 5804/5804 R Centrifuge 5810/5810 R
English (EN)**10.6.3 Rotor A-4-44**










			Max. g-force: 4,400 × <i>g</i>
Rotor A-4-44	Rectangular bucket 100 mL	Aerosol-tight cap	Max. speed: 5,000 rpm
Swing-bucket rotor with 4 × 100 mL rectangular buckets			Max. load per bucket (adapter, tube and contents): 310 g

Tube	Tube Capacity Tubes per adapter/rotor	Adapter Order no. (international)	Adapter bottom shape Tube diameter Max. tube length with/without aerosol-tight bucket cap	Max. g-force Max. speed Centrifugation radius
	Micro test tube 1.5/2 mL 12/48	 5804 751.000	Flat Ø 11 mm 43 mm/43 mm	4,100 × <i>g</i> 5,000 rpm 14.8 cm
	Tubes 1.2 to 5 mL 14/56	 5804 750.004	Flat Ø 11 mm 102 mm/105 mm	4,200 × <i>g</i> 5,000 rpm 15.0 cm
	Tubes 2.6 to 7 mL 9/36	 5804 752.007	Flat Ø 13 mm 106 mm/108 mm	4,200 × <i>g</i> 5,000 rpm 15.0 cm
	Tubes 3 to 15 mL 7/28	 5804 753.003	Flat Ø 16 mm 106 mm/108 mm	4,200 × <i>g</i> 5,000 rpm 15.0 cm
	Tubes 7 to 17 mL 6/24	 5804 754.000	Flat Ø 17.5 mm 106 mm/110 mm	4,200 × <i>g</i> 5,000 rpm 15.0 cm

Tube	Tube Capacity Tubes per adapter/rotor	Adapter Order no. (international)	Adapter bottom shape Tube diameter Max. tube length with/without aerosol-tight bucket cap	Max. g-force Max. speed Centrifugation radius
	Conical tube 15 mL 4/16	 5804 755.006	Conical Ø 17.5 mm -/121 mm	4,300 × g 5,000 rpm 15.5 cm
	Conical tube 15 mL 2/8	 5804 717.007	Conical Ø 17.5 mm 121 mm/121 mm	4,400 × g 5,000 rpm 15.7 cm
	Tube 7 to 18 mL 4/16	 5804 756.002	Flat Ø 20 mm 104 mm/107 mm	4,200 × g 5,000 rpm 15.0 cm
	Tube 18 to 30 mL 2/8	 5804 757.009	Flat Ø 26 mm 100 mm/110 mm	4,200 × g 5,000 rpm 15.0 cm
	Conical tube 50 mL 1/4	 5804 758.005	Conical Ø 31 mm -/122 mm	4,300 × g 5,000 rpm 15.5 cm
	Conical tube 50 mL 1/4	 5804 718.003	Conical Ø 31 mm 119 mm/122 mm	4,400 × g 5,000 rpm 15.7 cm
	Conical tube 50 mL -/8	 5804 706.005  Max. load 144 g (insert, tubes and contents)	flat with conical insert - -/120 mm	4,500 × g 5,000 rpm 16.1 cm

Technical data

 Centrifuge 5804/5804 R Centrifuge 5810/5810 R
 English (EN)

Tube	Tube Capacity Tubes per adapter/rotor	Adapter Order no. (international)	Adapter bottom shape Tube diameter Max. tube length with/without aerosol-tight bucket cap	Max. g-force Max. speed Centrifugation radius
	Tube 30 to 50 mL 1/4	 5804 759.001	Flat Ø 31 mm 108 mm/122 mm	4,200 × <i>g</i> 5,000 rpm 15.0 cm
	Conical tube, skirted 50 mL 1/4	 5804 759.001  5804 728.009	Flat Ø 31 mm 108 mm/122 mm	4,200 × <i>g</i> 5,000 rpm 15.0 cm
	Tube 50 to 75 mL 1/4	 5804 760.000	Flat Ø 35 mm 108 mm/119 mm	4,200 × <i>g</i> 5,000 rpm 15.0 cm
	Tube 80 to 100 mL 1/4	 5804 761.006	Flat Ø 45 mm 100 mm/114 mm	4,200 × <i>g</i> 5,000 rpm 15.0 cm

10.6.4 Rotor A-2-DWP-AT (only 5810/5810 R)

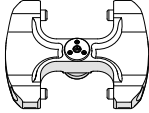
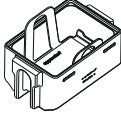
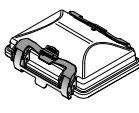
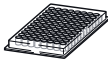
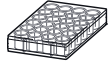
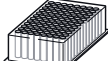
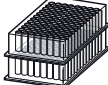

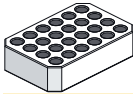

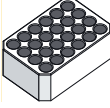
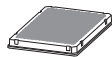
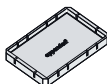
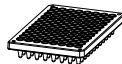
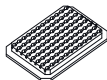
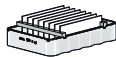
			Max. <i>g</i> -force:	3486 × <i>g</i>
Rotor A-2-DWP-AT	Bucket	Aerosol-tight cap	Max. speed:	4500 rpm
Swing-bucket rotor with 2 aerosol-tight buckets (always use with a plate carrier)			Max. load per bucket (adapter, plate and contents):	500 g

Plate	Plate Capacity Plate/ slide per adapter/rotor	Adapter Order no. (international)	Adapter bottom shape Max. loading height	Max. <i>g</i> -force Max. speed Centrifugation radius
	Microplate 96/384 wells 4/16	-	60 mm	3486 × <i>g</i> 4500 rpm 154 mm
	Cell-culture plate 2/4	-	60 mm	3486 × <i>g</i> 4500 rpm 154 mm
	Deepwell plate 96 mL 1/2	-	Flat 67 mm	3486 × <i>g</i> 4500 rpm 154 mm
	Kit 1/2	-	60 mm	3486 × <i>g</i> 4500 rpm 154 mm
	IsoRack 24 × 0.5 mL micro test tubes 1/2	 5825 708.008 SBS adapter 5825 718.003	Open Ø 6 mm 60 mm	2500 × <i>g</i> 3900 rpm 147 mm
	IsoRack 24 × 1.5/2.0 mL micro test tubes 1/2	 5825 709.004 SBS adapter 5825 718.003	Open Ø 11 mm 60 mm	2432 × <i>g</i> 3900 rpm 143 mm

Technical data

Centrifuge 5804/5804 R Centrifuge 5810/5810 R
English (EN)

Plate	Plate Capacity Plate/ slide per adapter/rotor	Adapter Order no. (international)	Adapter bottom shape Max. loading height	Max. g-force Max. speed Centrifugation radius
	PCR plate 384 wells 1/2	 5825 713.001	60 mm	$3373 \times g$ 4500 rpm 149 mm
	PCR plate 96 wells 1/4	 5825 711.009	60 mm	$3486 \times g$ 4500 rpm 154 mm
Slide	CombiSlide 8 slides 8/16	 5825 706.005	Flat 60 mm	$100 \times g$ 772 rpm 150 mm

10.6.5 Rotor A-2-DWP

If you are using two fully loaded DWP plates, check the load.

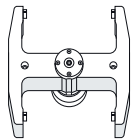
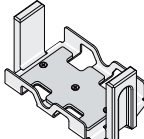
		Max. g-force: $2,250 \times g$
Rotor A-2-DWP Swing-bucket rotor with 2 Deepwell plate buckets	Deepwell plate bucket	Max. speed: 3.700 rpm Max. load per bucket 380 g (adapter, plate and contents):

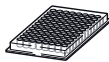
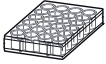
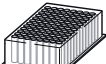
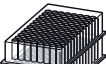

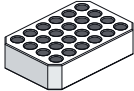

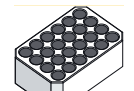


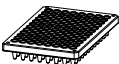


Plate	Plate Capacity Plates/slides per adapter/rotor	Adapter Order no. (international)	Adapter bottom shape Max. loading height	Max. g-force Max. speed Centrifugation radius
	Microplate 96/384 wells 4/8		Flat 89 mm	$2,250 \times g$ 3.700 rpm 14.7 cm

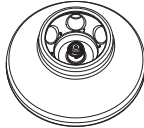
Plate	Plate Capacity Plates/slides per adapter/rotor	Adapter Order no. (international)	Adapter bottom shape Max. loading height	Max. g-force Max. speed Centrifugation radius
	Cell-culture plate 4/8		Flat 89 mm	2,250 × <i>g</i> 3.700 rpm 14.7 cm
	Deepwell plate 96 wells 2/4		Flat 89 mm	2,250 × <i>g</i> 3.700 rpm 14.7 cm
	Kit 1/2		Flat 89 mm	2,250 × <i>g</i> 3.700 rpm 14.7 cm
	Micro test tube in IsoRack 24 x 0.5 mL 1/2	 5825 708.008 SBS adapter 5825 718.003	Flat Ø 6 mm 89 mm	2,050 × <i>g</i> 3.700 rpm 13.8 cm
	Micro test tube in IsoRack 24 x 1.5/2 mL 1/2	 5825 709.004 SBS adapter 5825 718.003	Flat Ø 11 mm 89 mm	1,990 × <i>g</i> 3.700 rpm 13.3 cm
	384-well PCR plate 1/2	 5825 713.001	Flat 89 mm	2,170 × <i>g</i> 3.700 rpm 14.2 cm
	96-well PCR plate 1/2	 5825 711.009	Flat 89 mm	2,220 × <i>g</i> 3,700 rpm 14.5 cm
Slide	CombiSlide 8 slides 8/16	 5825 706.005	Flat 60 mm	100 × <i>g</i> 791 rpm 14.3 cm












*) Optional. Secures the plate against slipping.











Technical data

Centrifuge 5804/5804 R Centrifuge 5810/5810 R
English (EN)

10.6.6 Rotor FA-45-6-30

	Rotor FA-45-6-30 Fixed-angle rotor for 6 conical tubes	Max. g-force: 16639 × <i>g</i> (5810 R: 20,133 × <i>g</i>)
		Max. speed: 11000 rpm (5810 R: 12,100 rpm)
		Max. load (adapter, tube and contents): 6 × 75 <i>g</i>

Tube	Tube Capacity Tubes per adapter/rotor	Adapter Order no. (international)	Adapter bottom shape Tube diameter Max. tube length with rotor lid	Max. g-force at 11,000 rpm (5804/ 5804 R/5810) Max. g-force at 12,100 rpm (5810 R) Centrifugation radius
	Conical tube 15 mL 1/6	 5820 717.009	Conical Ø 17 mm 125 mm	16233 × <i>g</i> 19642 × <i>g</i> 12.0 cm
	Conical tube 50 mL 1/6	-	Conical Ø 29.6 mm 127 mm	16639 × <i>g</i> 20133 × <i>g</i> 12.3 cm
	Oak Ridge 16 mL 1/6	 5820 720.000	Round Ø 18.1 mm 107 mm	16233 × <i>g</i> 19642 × <i>g</i> 12.0 cm
	Oak Ridge 30 mL 1/6	 5820 721.006	Round Ø 25.7 mm 104 mm	14204 × <i>g</i> 17187 × <i>g</i> 10.5 cm
	Oak Ridge 35 mL 1/6	 5820 722.002	Conical Ø 28.7 mm 113 mm	15151 × <i>g</i> 18333 × <i>g</i> 11.2 cm
	Micro test tube 5 mL 1/6	 5820 730.005	Conical Ø 17 mm -	16369 × <i>g</i> 19806 × <i>g</i> 12.1 cm

Tube	Tube Capacity Tubes per adapter/rotor	Adapter Order no. (international)	Adapter bottom shape Tube diameter Max. tube length with rotor lid	Max. g-force at 11,000 rpm (5804/ 5804 R/5810) Max. g-force at 12,100 rpm (5810 R) Centrifugation radius
	Tube 2.6 to 5 mL 1/6	 5820 726.008	Round Ø 13.5 mm -	16233 × g 19642 × g 12.0 cm
	Tube 4 to 8 mL 1/6	 5820 725.001	Round Ø 13.5 mm 119 mm	16233 × g 19642 × g 12.0 cm
	Tube 5.5 mL – 10 mL 1/6	 5820 728.000	Round Ø 16 mm -	16233 × g 19642 × g 12.0 cm
	Tube 7.5 to 12 mL 1/6	 5820 727.004	Round Ø 16.4 mm 119 mm	16233 × g 19642 × g 12.0 cm
	Tube 9 mL 1/6	 5820 729.007	Round Ø 16.4 mm 112 mm	16233 × g 19642 × g 12.0 cm

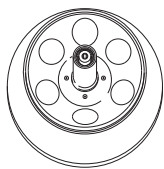














► Do not use Corning® 50 mL PET Centrifuge Tubes in the rotor FA-45-6-30. These tubes may remain stuck in the bores after centrifugation.

Technical data

Centrifuge 5804/5804 R Centrifuge 5810/5810 R
English (EN)

10.6.7 Rotor F-34-6-38

	Rotor F-34-6-38 Fixed-angle rotor for 6 × 85 mL tubes	Max. g-force: 15,557 × <i>g</i> (5810 R: 18,514 × <i>g</i>)
		Max. speed: 11 000 rpm (5810 R: 12 000 rpm)
		Max. load (adapter, tube and contents): 6 × 125 g


Tube	Tube Capacity Tubes per adapter/rotor	Adapter Order no. (international)	Adapter bottom shape Tube diameter Max. tube length with rotor lid	Max. g-force at 11 000 rpm (5804/ 5804 R/5810) Max. g-force at 12 000 rpm (5810 R) Centrifugation radius
	Micro test tube 1.5/2 mL 4/24	 5804 770.005	Round Ø 11 mm 43 mm	15 300 × <i>g</i> 18 200 × <i>g</i> 11.3 cm
	Micro test tube 5 mL 1/6	 5804 777.000	Conical Ø 17 mm -	14 150 × <i>g</i> 16 842 × <i>g</i> 10.45 cm
	Blood collection tube 2 mL to 5 mL 3/18	 5804 738.004	Round Ø 13 mm 80 mm	14 339 × <i>g</i> 17 065 × <i>g</i> 10.6 cm
	Blood collection tube 4 mL to 7 mL 3/18	 5804 739.000	Round Ø 13 mm 107 mm	15 442 × <i>g</i> 18 353 × <i>g</i> 11.4 cm
	Tube 7 mL to 15 mL 2/12	 5804 771.001	Round Ø 16 mm 112 mm	15 150 × <i>g</i> 18 000 × <i>g</i> 11.2 cm
	Conical tube 15 mL 1/6	 5804 776.003	Conical Ø 17.5 mm 123 mm	14 450 × <i>g</i> 17 200 × <i>g</i> 10.7 cm











Tube	Tube Capacity Tubes per adapter/rotor	Adapter Order no. (international)	Adapter bottom shape Tube diameter Max. tube length with rotor lid	Max. g-force at 11 000 rpm (5804/ 5804 R/5810) Max. g-force at 12 000 rpm (5810 R) Centrifugation radius
	Tube 15 mL to 18 mL 1/6	 5804 772.008	Round Ø 18 mm 123 mm	14750 × g 17550 × g 10.9 cm
	Tube 20 mL to 30 mL 1/6	 5804 773.004	Round Ø 26 mm 123 mm	14900 × g 17700 × g 11.0 cm
	Tube 50 mL 1/6	 5804 774.000	Round Ø 29 mm 123 mm	15157 × g 18014 × g 11.2 cm
	Conical tube 25 mL 1/6	 5804 775.007  5820 734.000	Conical Ø 30 mm 78.5 mm	14070 × g - 8.7 cm
	Conical tube 50 mL 1/6	 5804 775.007	Conical Ø 30 mm 117 mm	14600 × g 17387 × g 10.8 cm
	Conical tube 50 mL 1/6	 5804 775.007	Conical Ø 30 mm 118 mm	14600 × g 17387 × g 10.8 cm
	Tube 85 mL -/6	-	- Ø 38.2 mm 121 mm	15550 × g 18500 × g 11.5 cm

Technical data


Centrifuge 5804/5804 R Centrifuge 5810/5810 R
English (EN)



10.6.8 Rotor FA-45-30-11 and F-45-30-11

	Max. <i>g</i> -force:	20817 × <i>g</i>
	Max. rotational speed:	14000 rpm
Rotor FA-45-30-11 Aerosol-tight fixed-angle rotor for 30 micro test tubes Rotor F-45-30-11 Fixed-angle rotor for 30 micro test tubes	Max. load (adapter, tube and contents):	30 × 3.5 g


 Tube	Tube Capacity Tubes per adapter/ rotor	Adapter	Bottom shape Diameter	Max. <i>g</i> -force Max. rotational speed Radius
		Order no. (international)		
	Micro test tube 1.5/2 mL –/30	–	– Ø 11 mm	20817 × <i>g</i> 14000 rpm 9.5 cm
	PCR tube 0.2 mL 1/30	 5425 715.005	conical Ø 6 mm	16200 × <i>g</i> 14000 rpm 7.4 cm
	Micro test tube 0.4 mL 1/30	 5425 717.008	conical Ø 6 mm	20817 × <i>g</i> 14000 rpm 9.5 cm
	Micro test tube 0.5 mL 1/30	 5425 716.001	open Ø 8 mm	18400 × <i>g</i> 14000 rpm 8.4 cm
	Microtainers 0.6 mL 1/30	 5425 716.001	open Ø 8 mm	20817 × <i>g</i> 14000 rpm 9.5 cm



10.6.9 Rotor F-45-48-PCR

	Rotor F-45-48-PCR Fixed-angle rotor for tube strips or 0.2 mL PCR tubes	Max. g-force: 15,294 × <i>g</i>
		Max. speed: 12,000 rpm
		Max. load (tube and contents): 6 × 3.5 g

Vessel	Vessel Capacity Vessels per adapter/rotor	Adapters	Tube diameter	Max. g-force Max. speed Centrifugation radius
	8-tube/5-tube tube strips 8/5 × 0,2 mL -/6 × 8 and/or -/ 6 × 5	-	Ø 6 mm	15,294 × <i>g</i> 12,000 rpm 9.5 cm
	Vessel 0.2 mL -/48	-	Ø 6 mm	15,294 × <i>g</i> 12,000 rpm 9.5 cm

10.6.10 Rotor T-60-11




	Rotor T-60-11 Drum rotor for micro test tubes	Max. g-force: 14000 × <i>g</i>
		Max. speed: 14000 rpm
		Max. load (tube and contents): 6 × 70 g


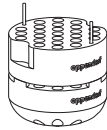



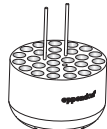

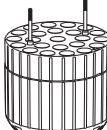
Tube	Tube Capacity Tubes per adapter/rotor	Adapter	Tube diameter	Max. g-force Max. speed Centrifugation radius
	Micro test tube 1.5/2 mL 10/60	-	Ø 11 mm	16435 × <i>g</i> 14000 rpm 7.5 cm
	Micro test tube 0.4 mL 20/120	-	Ø 6 mm	16435 × <i>g</i> 14000 rpm 7.5 cm


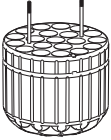

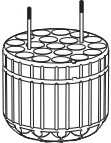

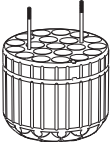



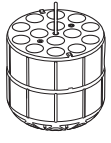

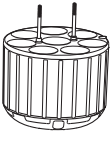
Technical data

Centrifuge 5804/5804 R Centrifuge 5810/5810 R
English (EN)

10.6.11 Rotor S-4-104 (only 5810/5810 R)


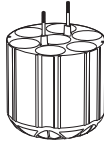


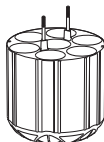


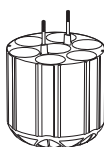


			Max. <i>g</i> -force:	3214 × <i>g</i>
Rotor S-4-104	Round bucket 750 mL	Aerosol-tight cap	Max. speed:	3900 rpm
Swing-bucket rotor with 4 × 750 mL round buckets			Max. load per bucket (adapter, tube and contents):	1000 g









Tube	Tube Capacity Tubes per adapter/rotor	Adapter Order no. (international)	Adapter bottom shape Tube diameter Max. tube length with/without aerosol-tight bucket cap	Max. <i>g</i>-force Max. speed Centrifugation radius
	Micro test tube 1.5/2 mL 50/200	 5825 740.009	Open Ø 11 mm 39 mm	3162 × <i>g</i> 3900 rpm 18.6 cm
	Micro test tube 5 mL 14/56	 5825 734.009 (without upper part)	Conical Ø 17 mm 60 mm	3197 × <i>g</i> 3900 rpm 18.8 cm
	Round-bottom tube Ø 12 mm × 75 mm 27/108	 5825 747.003	Round Ø 12 mm 108 mm/115 mm	3078 × <i>g</i> 3900 rpm 18.1 cm
	Tube 4 to 8 mL 23/92	 5825 738.004	Round Ø 13 mm × 100 mm 107 mm/112 mm	3044 × <i>g</i> 3900 rpm 17.9 cm

Tube	Tube Capacity Tubes per adapter/rotor	Adapter Order no. (international)	Adapter bottom shape Tube diameter Max. tube length with/without aerosol-tight bucket cap	Max. <i>g</i> -force Max. speed Centrifugation radius
	Tube 7.5 to 12 mL 20/80	 5825 736.001	Round Ø 16 mm × 98 mm 114 mm/119 mm	3112 × <i>g</i> 3900 rpm 18.3 cm
	Tube 8 mL to 16 mL 7/28 (Load inner bores only (Fig. 5-5 on p. 33))	 5825 736.001	Round Ø 16 mm (Do not use an aerosol-tight cap.)/125 mm	3061 × <i>g</i> 3900 rpm 18 cm
	Tube 9 mL 20/80	 5825 743.008	Round Ø 17.5 mm × 100 mm 106 mm/111 mm	3044 × <i>g</i> 3900 rpm 17.9 cm
	Round-bottom tube 14 mL 14/56	 5825 748.000	Round Ø 17.5 mm 112 mm/117 mm	3027 × <i>g</i> 3900 rpm 17.8 cm
	Conical tube 15 mL 14/56	 5825 734.009	Conical Ø 17 mm × 104 mm 121 mm/125 mm	3197 × <i>g</i> 3900 rpm 18.8 cm
	Conical tube (skirted) 30 mL 8/32	 5825 755.006	Flat Ø 25 mm 106 mm/112 mm	2976 × <i>g</i> 3900 rpm 17.5 cm

Technical data

 Centrifuge 5804/5804 R Centrifuge 5810/5810 R
 English (EN)

Tube	Tube Capacity Tubes per adapter/rotor	Adapter Order no. (international)	Adapter bottom shape Tube diameter Max. tube length with/without aerosol-tight bucket cap	Max. <i>g</i> -force Max. speed Centrifugation radius
	Conical tube 25 mL 7/28	 5825 733.002  5820 734.000	Conical Ø 30 mm × 109 mm 78.5 mm/78.5 mm	2567 × <i>g</i> 3900 rpm 15.1 cm
	Conical tube 25 mL 6/28	 5825 733.002 Middle bore not usable  5820 733.004	Conical Ø 30 mm × 109 mm 83 mm/83 mm	2737 × <i>g</i> 3900 rpm 16.1 cm
	Conical tube 50 mL 7/28	 5825 733.002	Conical Ø 30 mm × 109 mm 116 mm/122 mm	3180 × <i>g</i> 3900 rpm 18.7 cm
	Conical tube 50 mL 6/28	 5825 733.002 Middle bore not usable	Conical Ø 30 mm × 109 mm -/122 mm	3180 × <i>g</i> 3900 rpm 18.7 cm

Tube	Tube Capacity Tubes per adapter/rotor	Adapter Order no. (international)	Adapter bottom shape Tube diameter Max. tube length with/without aerosol-tight bucket cap	Max. <i>g</i> -force Max. speed Centrifugation radius
	Conical tube (skirted) 50 mL 5/20	 5825 732.006	Conical Ø 30 mm × 104 mm 116 mm/120 mm	3027 × <i>g</i> 3900 rpm 17.8 cm
	Centrifuge bottle 175 - 250 mL 1/4	 5825 741.005 The manufacturer's adapter is required for conical bottles	Flat Ø 62 mm × 129 mm 128.5 mm/ 145 mm	3146 × <i>g</i> 3900 rpm 18.5 cm
	Wide-neck bottle 750 mL 1/4	 5825 744.004	Flat Ø 102 mm × 132 mm (Do not use the aerosol-tight cap.)/140 mm	3146 × <i>g</i> 3900 rpm 18.5 cm
	Corning centrifuge bottle 500 mL 1/4	 5825 745.000	Conical Ø 96 mm (Do not use an aerosol-tight cap.)/147 mm	3180 × <i>g</i> 3900 rpm 18.7 cm

Technical data

Centrifuge 5804/5804 R Centrifuge 5810/5810 R
English (EN)

**NOTICE! Buckets swinging out in the wrong direction.**

If the wrong adapters are used for 500 mL Corning flasks, the buckets of the swing-bucket rotor may swing out in the wrong direction. If the buckets swing out in the wrong direction, this may lead to sample loss or damage to the centrifuge.

- ▶ Therefore, only use the Eppendorf adapter for 500 mL Corning flasks intended for this purpose.



Do not use an aerosol-tight bucket cap with Corning 50 mL conical tubes.




			Max. g-force:	2568 × g
Rotor S-4-104 Swing-bucket rotor with 4 × plate buckets	Plate bucket (always use with a plate carrier and a bottom element)	Aerosol-tight cap	Max. speed:	3900 rpm
			Max. load per bucket (plate carrier, bottom element, plate and contents):	530 g

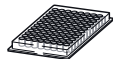
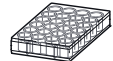
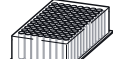


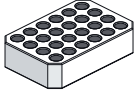

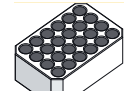

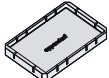
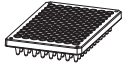
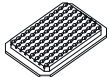
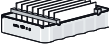



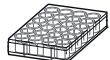
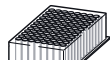
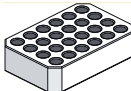

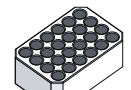

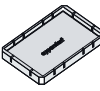
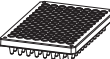
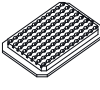

Plate	Plate Capacity Plates/slides per adapter/rotor	Adapter Order no. (international)	Adapter bottom shape Max. loading height	Max. g-force Max. speed Centrifugation radius
	Microplate 96/384 wells 4/16	–	Flat – 47 mm/60 mm	2568 × g 3900 rpm 15.1 cm
	Cell-culture plate 2/8	–	Flat – 47 mm/60 mm	2568 × g 3900 rpm 15.1 cm
	Deepwell plate 96 wells 1/4	–	Flat – 47 mm/60 mm	2568 × g 3900 rpm 15.1 cm
	Kit 1/4	–	Flat – 47 mm/60 mm	2568 × g 3900 rpm 15.1 cm



Plate	Plate Capacity Plates/slides per adapter/rotor	Adapter Order no. (international)	Adapter bottom shape Max. loading height	Max. <i>g</i> -force Max. speed Centrifugation radius
	IsoRack 24 × 0.5 mL micro test tubes 1/4	 5825 708.008	Open Ø 6 mm 47 mm/60 mm	2449 × <i>g</i> 3900 rpm 14.4 cm
	IsoRack 24 × 1.5/2 mL micro test tubes 1/4	 5825 709.004	Open Ø 11 mm 47 mm/60 mm	2381 × <i>g</i> 3900 rpm 14.0 cm
	PCR plate 384 wells 1/4	 5825 713.001	Flat 47 mm/60 mm	2415 × <i>g</i> 3900 rpm 14.2 cm
	PCR plate 96 wells 1/2	 5825 711.009	Conical 47 mm/60 mm	2449 × <i>g</i> 3900 rpm 14.4 cm
Slide	CombiSlide 12 slides 12/48	 5825 706.005	Flat 47 mm/60 mm	1000 × <i>g</i> 2467 rpm 14.7 cm
			Max. <i>g</i> -force:	2568 × <i>g</i>
Rotor S-4-104	Plate bucket (always use with a plate carrier)		Max. speed:	3900 rpm
Swing-bucket rotor with 4 × plate buckets			Max. load per bucket (adapter, plate and contents):	450 g













Technical data

Centrifuge 5804/5804 R Centrifuge 5810/5810 R
English (EN)

Plate	Plate Capacity Plates/slides per adapter/rotor	Adapter Order no. (international)	Adapter bottom shape Max. loading height	Max. <i>g</i> -force Max. speed Centrifugation radius
	Microplate 96/384 wells 4/16	–	Flat – 47 mm/60 mm	2568 × <i>g</i> 3900 rpm 15.1 cm
	Cell-culture plate 2/8	–	Flat – 47 mm/60 mm	2568 × <i>g</i> 3900 rpm 15.1 cm
	Deepwell plate 96 wells 1/4	–	Flat – 47 mm/60 mm	2568 × <i>g</i> 3900 rpm 15.1 cm
	Kit 1/4	–	Flat – 47 mm/60 mm	2568 × <i>g</i> 3900 rpm 15.1 cm
	IsoRack 24 × 0.5 mL micro test tubes 1/4	 5825 708.008	Open Ø 6 mm 47 mm/60 mm	2449 × <i>g</i> 3900 rpm 14.4 cm
	IsoRack 24 × 1.5/2 mL micro test tubes 1/4	 5825 709.004	Open Ø 11 mm 47 mm/60 mm	2381 × <i>g</i> 3900 rpm 14.0 cm
	PCR plate 384 wells 1/4	 5825 713.001	Flat 47 mm/60 mm	2415 × <i>g</i> 3900 rpm 14.2 cm
	PCR plate 96 wells 1/2	 5825 711.009	Conical 47 mm/60 mm	2449 × <i>g</i> 3900 rpm 14.4 cm
Slide	CombiSlide 12 slides 12/48	 5825 706.005	Flat 47 mm/60 mm	1000 × <i>g</i> 2467 rpm 14.7 cm
















10.6.12 Rotor S-4-72

		Max. g-force:	3234 × <i>g</i>
Rotor S-4-72 Swing-bucket rotor with 4 × 250 mL round buckets	Round bucket 250 mL	Max. speed:	4200 rpm
		Max. load per bucket (adapter, tube and contents):	450 g

Tube	Tube Capacity Tubes per adapter/ rotor	Adapter Order no. (international)	Adapter bottom shape Tube diameter Max. tube length	Max. g-force Max. speed Centrifugation radius
	Micro test tube 1.5/2 mL 23/104	 5804 794.001	Open Ø 11 mm 43 mm	3136 × <i>g</i> 4200 rpm 15.9 cm
	Micro test tube 5 mL 8/32	 5804 793.005	Conical Ø 17 mm × 60 mm	3215 × <i>g</i> 4200 rpm 16.3 cm
	Tube 4 to 8 mL 14/56	 5804 789.008	Round Ø 13 mm × 104 mm 115 mm	3136 × <i>g</i> 4200 rpm 15.9 cm
	Tube 7.5 to 12 mL 13/52	 5804 791.002	Round Ø 16 mm × 98 mm 112 mm	3096 × <i>g</i> 4200 rpm 15.7 cm
	Tube 9 mL 12/48	 5804 792.009	Round Ø 17.5 mm × 100 mm 113 mm	3116 × <i>g</i> 4200 rpm 15.8 cm
	Conical tube 15 mL 8/32	 5804 783.000	Conical Ø 17 mm × 104 mm 120 mm	3234 × <i>g</i> 4200 rpm 16.4 cm

Technical data


Centrifuge 5804/5804 R Centrifuge 5810/5810 R
English (EN)





Tube	Tube Capacity Tubes per adapter/ rotor	Adapter Order no. (international)	Adapter bottom shape Tube diameter Max. tube length	Max. g-force Max. speed Centrifugation radius
	Conical tube 25 mL 4/16	 5804 784.006  5820 734.000	Conical Ø 29.8 mm 84,5 mm	2701 rpm 4200 rpm 13.7 cm
	Conical tube 25 mL 4/16	 5804 784.006  5820 733.004	Conical Ø 29.8 mm 91 mm	2524 rpm 4200 rpm 12.8 cm
	Conical tube 50 mL 4/16	 5804 784.006	Conical Ø 30 mm 120 mm	3234 × g 4200 rpm 16.4 cm
	Conical tube 50 mL 4/16	 5804 784.006	Conical Ø 30 mm 118 mm	3234 × g 4200 rpm 16.4 cm
	Conical tube, skirted 50 mL 2/8	 5804 785.002	Conical Ø 29 mm × 104 mm 120 mm	2602 × g 3900 rpm 15.3 cm
 	Centrifuge bottle 1/4	 5804 787.005 The manufacturer's adapter is required for conical bottles	Flat Ø 62 mm 130 mm	3155 × g 4200 rpm 16 cm



Only centrifuge conical tubes with the manufacturer's adapter.

10.6.13 Rotor F-35-48-17


	Max. <i>g-force</i> :	5005 × <i>g</i>
Rotor F-35-48-17 Fixed-angle rotor with 48 steel cores	Max. speed:	5500 rpm
	Max. load (sleeve, adapter, tube and contents):	48 × 56 g










Tube	Tube Capacity Tubes per adapter/ rotor	Adapter	Bottom shape	Max. <i>g-force</i>
			Tube diameter Max. tube length	Max. speed Radius
	Tube 7.5 to 12 mL 1/48	 5702701.009	Flat Ø 16 mm 127 mm	5005 × <i>g</i> 5500 rpm 14.8 cm
	Conical tube 15 mL 1/40	 5702708.003	Conical Ø 17 mm 127 mm	5005 × <i>g</i> 5500 rpm 14.8 cm

Technical data

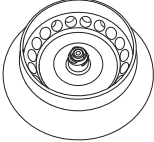
Centrifuge 5804/5804 R Centrifuge 5810/5810 R
English (EN)








10.6.14 Rotor FA-45-48-11

	Max. g-force: Outer ring 19,083 x <i>g</i> Inner ring 16,816 x <i>g</i>
Rotor FA-45-48-11 Aerosol-tight fixed-angle rotor for 48 tubes	Max. speed: 13,000 rpm Max. load (adapter, tube and contents): 48 x 3.75 g

Tube	Tube Capacity Tubes per adapter/rotor	Adapter Order no. (international)	Adapter bottom shape Tube diameter	Max. g-force Outer ring Inner ring Max. speed Centrifugation radius Outer ring Inner ring
	Reaction tube 1.5 to 2 mL -/48		round Ø 11 mm	19,083 x <i>g</i> 16,816 x <i>g</i> 13,000 rpm 10.1 cm 8.9 cm
	PCR tube 0.2 mL 1/48	 5425 715.005	conical Ø 6 mm	15,115 x <i>g</i> 12,848 x <i>g</i> 13,000 rpm 8 cm 6.8 cm
	Reaction tube 0.4 mL 1/48	 5425 717.008	conical Ø 6 mm	19,083 x <i>g</i> 16,816 x <i>g</i> 13,000 rpm 10.1 cm 8.9 cm
	Reaction tube 0.5 mL 1/48	 5425 716.001	– Ø 8 mm	17,005 x <i>g</i> 14,737 x <i>g</i> 13,000 rpm 9 cm 7.8 cm
	Reaction tube 0.6 mL 1/48	 5425 716.001	– Ø 8 mm	19,083 x <i>g</i> 16,816 x <i>g</i> 13,000 rpm 10.1 cm 8.9 cm

10.6.15 Rotor FA-45-20-17

	Max. g-force: 20,913 × <i>g</i>
Rotor FA-45-20-17 Aerosol-tight fixed-angle rotor for 20 tubes	Max. speed: 13,100 rpm
	Max. load (adapter, tube and contents): 20 × 9.5 g

Tube	Tube Capacity Tubes per adapter/rotor	Adapter Order no. (international)	Adapter bottom shape Tube diameter	Max. g-force Max. speed Centrifugation radius
	Reaction tube 1.5 mL/2.0 mL 1/20	 5820 768.002	open Ø 11 mm	18,227 × <i>g</i> 13,100 rpm 9.5 cm
	Reaction tube 5 mL -/20	—	conical Ø 17 mm	20,913 × <i>g</i> 13,100 rpm 10.9 cm
	HPLC vessels 1/20	 5820 770.007	open Ø 11 mm	17,076 × <i>g</i> 13,100 rpm 8.9 cm
	Cryo tube 1.0 mL/2.0 mL 1/12	 5820 769.009	flat Ø 13 mm	18,802 × <i>g</i> 13,100 rpm 9.8 cm

Technical data

Centrifuge 5804/5804 R Centrifuge 5810/5810 R
English (EN)

11 Ordering Information

11.1 Rotors

11.1.1 Rotor A-4-81 (only 5810/5810 R)

11.1.1.1 Rotor A-4-81, 500 mL bucket

Order no. (International)	Order no. (North America)	Description
5810 718.007	022638602	Rotor A-4-81 for 500 mL rectangular buckets or MTP/Flex-buckets incl. 4 x 500 mL rectangular buckets
5810 743.001	5810743001	Rotor A-4-81 without buckets
5810 730.007	022638629	Rectangular bucket 500 mL Set of 4
5810 724.007	022638661	Aerosol-tight cap for 500 mL rectangular buckets, 2 pieces
5810 745.004 5810 746.000	022638704 022638707	Adapter for 500 mL rectangular buckets for 20 sample tubes (1.5/2.0 mL, max. Ø 11 mm), set of 2 for 20 blood collection tubes (1.2 – 5 mL, max. Ø 11 mm), set of 2
5810 720.001	022638700	for 24 tubes (2.6 – 7 mL, max. Ø 13 mm), set of 2
5825 717.007	022638718	for 18 tubes (5 mL, Monovette, max. Ø 13 mm), set of 2
5810 748.003	022638721	for 16 blood collection tubes (3 – 15 mL, max. Ø 16 mm), set of 2
5810 721.008	022638726	for 16 tubes (7 – 17 mL, max. Ø 17.5 mm), set of 2
5810 722.004	022638742	for 12 conical tubes (15 mL, max. Ø 17.5 mm), set of 2
5810 723.000	022638769	for 5 conical tubes (50 mL, max. Ø 31 mm), set of 2
5810 739.004	022638904	for 5 Centrifugal Filter Units (max. Ø 31 mm), set of 2
5825 722.000	022638921	for 1 bottle (180 – 250 mL, max. Ø 62 mm), set of 2
5810 728.002	022638785	for 1 bottle (400 mL, max. Ø 81 mm), set of 2
5804 737.008	022654373	Adapter for 50 mL skirted conical tubes, set of 8
5810 734.002	022638688	Rubber mat for adapters for 500 mL rectangular buckets 4 pieces
5810 735.009	022638696	Replacement clamp for adapters for 500 mL rectangular buckets 2 pieces
5810 729.009	022638653	Wide-neck bottle 400 mL, lid blue, for rotor A-4-81 400 mL, lid blue, set of 2
5820 707.003	022638657	Wide-neck bottle 500 mL, for rotor A-4-81 500 mL, rectangular, set of 2
5810 718.309	022664174	Rotor key for Rotor A-4-81, S-4-104

Ordering Information

Centrifuge 5804/5804 R Centrifuge 5810/5810 R
English (EN)

11.1.1.2 Rotor A-4-81, MTP/Flex buckets

Order no. (International)	Order no. (North America)	Description
5810 725.003	022638807	Rotor A-4-81-MTP/Flex Swing-bucket rotor, incl. 4 MTP/Flex buckets
5810 741.009	022638840	MTP/Flex buckets for use with IsoRack and cell culture flask adapters as well as MTP and DWP 4 pieces
5810 742.005	022638866	2 pieces
5825 708.008	022638980	IsoRack adapter for 24 × 0.5 mL tubes in the IsoRack, 2 pcs.
5825 709.004	022638998	for 24 × 1.5/2.0 mL tubes in the IsoRack, 2 pcs.
5825 721.004	022510070	IsoRack starter set for Flex buckets 2 × IsoRack Adapter, 2 × IsoRacks with lid, 2 × IsoPack 0 °C for 0.5 mL and 1.5/2.0 mL tubes
5825 711.009	022638947	Adapter used in A-4-81-MTP/Flex, A-4-62-MTP, A-2-DWP-AT and A-2-DWP for 96-well PCR plates, set of 2
5825 713.001	022638955	for 384-well PCR plates, set of 2
5825 706.005	022638963	Adapter used in A-4-81-MTP/Flex, A-4-62-MTP and A-2-DWP CombiSlide Adapter, set of 2
5825 719.000	5825719000	Adapter used in A-4-81-MTP/Flex and A-4-62-MTP for 1 cell culture bottle, set of 2

11.1.1.3 Rotor A-4-81, buckets for conical tubes

Order no. (International)	Order no. (North America)	Description
5825 730.003	5825730003	Bucket for 7 × 50 mL conical tubes for Rotor A-4-81 set of 4 pcs.
5820 718.005	5820718005	Adapter used in FA-45-6-30 for 15 mL conical tubes, set of 7

11.1.2 Rotor A-4-62 and A-4-62-MTP (only 5810/5810 R)

11.1.2.1 Rotor A-4-62

Order no. (International)	Order no. (North America)	Description
5810 709.008	022638009	Rotor A-4-62 incl. 4 × 250 mL rectangular buckets
5810 716.004	022638084	Rectangular bucket 250 mL Set of 4
5810 710.006	022638033	Aerosol-tight cap for 250 mL rectangular buckets, set of 2
5810 751.004	022638220	Adapter for 250 mL rectangular buckets for 16 sample tubes (1.5/2.0 mL, max. Ø 11 mm), set of 2 for 25 tubes (1.2 – 5 mL, max. Ø 11 mm), set of 2 for 15 tubes (2.6 – 7 mL, max. Ø 13 mm), set of 2 for 12 tubes (3 – 15 mL, max. Ø 16 mm), set of 2 for 12 tubes (7 – 17 mL, max. Ø 17.5 mm), set of 2 for 8 tubes (7 – 18 mL, max. Ø 20 mm), set of 2 for 4 tubes (18 – 30 mL, max. Ø 26 mm), set of 2 for 4 tubes (30 – 50 mL, max. Ø 31 mm), set of 2 for 2 tubes (50 – 75 mL, max. Ø 35 mm), set of 2 for 1 tube (80 – 120 mL, max. Ø 45 mm), set of 2 for 1 bottle (180 – 250 mL, max. Ø 62 mm), set of 2 for 9 conical tubes (15 mL, max. Ø 17.5 mm), set of 2 for 3 conical tubes (50 mL, max. Ø 31 mm), set of 2 for 4 conical tubes (50 mL), operation w/o aerosol-tight cap, set of 2
5810 750.008	022638203	
5810 752.000	022638246	
5810 753.007	022638262	
5810 754.003	022638301	
5810 756.006	022638327	
5810 757.002	022638360	
5810 759.005	022638386	
5810 760.003	022638408	
5810 761.000	022638424	
5810 770.009	022638441	
5810 755.000	022638289	
5810 758.009	022638343	
5810 763.002	022638351	
5804 737.008	022654373	Adapter for 50 mL skirted conical tubes, set of 8
5810 782.007	022638483	Rubber mat for adapters for 250 mL rectangular buckets Set of 4
5810 781.000	022662431	Replacement clamp for adapters for 250 mL rectangular buckets Set of 2
5810 783.003	022638459	Rubber mat for adapter 5810 770.009/022638441 Set of 4

Ordering InformationCentrifuge 5804/5804 R Centrifuge 5810/5810 R
English (EN)**11.1.2.2 Rotor A-4-62-MTP**

Order no. (International)	Order no. (North America)	Description
5810 711.002	022638041	Rotor A-4-62-MTP incl. 4 MTP buckets
5810 702.003	022638068	MTP bucket for A-4-62 for 4 MTP or 1 DWP Set of 4
5825 711.009 5825 713.001	022638947 022638955	Adapter used in A-4-81-MTP/Flex, A-4-62-MTP, A-2-DWP-AT and A-2-DWP for 96-well PCR plates, set of 2 for 384-well PCR plates, set of 2
5825 706.005	022638963	Adapter used in A-4-81-MTP/Flex, A-4-62-MTP and A-2-DWP CombiSlide Adapter, set of 2

11.1.3 Rotor A-4-44

Order no. (International)	Order no. (North America)	Description
5804 709.004	022637401	Rotor A-4-44 incl. 4 × 100 mL rectangular buckets
5804 741.005	022637436	Rectangular bucket 100 mL 4 pieces
5804 712.005	022637428	Aerosol-tight cap for 100 mL rectangular buckets, set of 2
5804 751.000 5804 750.004 5804 752.007 5804 753.003 5804 754.000 5804 756.002 5804 757.009 5804 759.001 5804 760.000 5804 761.006 5804 755.006 5804 717.007	022637525 022637509 022637541 022637568 022637584 022637622 022637649 022637681 022637703 022637720 022637606 022637614	Adapter for 100 mL rectangular bucket for 12 sample tubes (1.5/2.0 mL, max. Ø 11 mm), set of 2 for 14 tubes (1.2 – 5 mL, max. Ø 11 mm), set of 2 for 9 tubes (2.6 – 7 mL, max. Ø 13 mm), set of 2 for 7 tubes (3 – 15 mL, max. Ø 16 mm), set of 2 for 6 tubes (7 – 17 mL, max. Ø 17.5 mm), set of 2 for 4 tubes (7 – 18 mL, max. Ø 20 mm), set of 2 for 2 tubes (18 – 30 mL, max. Ø 26 mm), set of 2 for 1 tube (30 – 50 mL, max. Ø 31 mm), set of 2 for 1 tube (50 – 75 mL, max. Ø 35 mm), set of 2 for 1 tube (80 – 100 mL, max. Ø 45 mm), set of 2 for 4 conical tubes (15 mL, max. Ø 17.5 mm), set of 2 for 2 conical tubes (15 mL, max. Ø 17.5 mm), not autoclavable, set of 2
5804 758.005 5804 718.003	022637665 022637673	for 1 conical tube (50 mL, max. Ø 31 mm), set of 2 for 1 conical tube (50 mL, max. Ø 31 mm), not autoclavable, set of 2
5804 737.008	022654373	Adapter for 50 mL skirted conical tubes, set of 8

Order no. (International)	Order no. (North America)	Description
5804 782.003	022662503	Rubber mat for adapters of Rotor A-4-44 Set of 4
5804 781.007	022662511	Replacement clamp for adapters of rotor A-4-44 Set of 2
5804 706.005	5804706005	Bucket for 2 × 50 mL conical tubes for Rotor A-4-44 set of 4 pcs.
5804 728.009	022637479	Adapter Form inserts for buckets with conical tubes for 1 conical tube (50 mL, max. Ø 31 mm), set of 8

11.1.4 Rotor A-2-DWP-AT (only 5810/5810 R)

Order no. (International)	Order no. (North America)	Description
5820 710.004	5820710004	Rotor A-2-DWP-AT incl. 2 buckets, 2 aerosol-tight caps and 2 plate holders
5820 711.000	5820711000	Bucket for rotor A-2-DWP-AT 2 pieces
5820 713.003	5820713003	Aerosol-tight cap 2 pieces
5820 712.007	5820712007	Plate carrier Rotors A-2-DWP-AT 2 pieces
5825 711.009	022638947	Adapter used in A-4-81-MTP/Flex, A-4-62-MTP, A-2-DWP-AT and A-2-DWP for 96-well PCR plates, set of 2
5825 713.001	022638955	for 384-well PCR plates, set of 2

Ordering Information

Centrifuge 5804/5804 R Centrifuge 5810/5810 R
English (EN)

11.1.5 Rotor A-2-DWP

Order no. (International)	Order no. (North America)	Description
5804 740.009	022638564	Rotor A-2-DWP Deepwell plates rotor, incl. 2 buckets
5804 743.008	022638556	Plate bucket used in A-2-DWP 2 pieces
5825 718.003	5825718003	SBS adapter for plates with rims in the SBS format Set of 2
5825 708.008 5825 709.004	022638980 022638998	IsoRack adapter for 24 × 0.5 mL tubes in the IsoRack, 2 pcs. for 24 × 1.5/2.0 mL tubes in the IsoRack, 2 pcs.
5825 711.009 5825 713.001	022638947 022638955	Adapter used in A-4-81-MTP/Flex, A-4-62-MTP, A-2-DWP-AT and A-2-DWP for 96-well PCR plates, set of 2 for 384-well PCR plates, set of 2
5825 706.005	022638963	Adapter used in A-4-81-MTP/Flex, A-4-62-MTP and A-2-DWP CombiSlide Adapter, set of 2

11.1.6 Rotor FA-45-6-30

Order no. (International)	Order no. (North America)	Description
5820 715.006	5820715006	Rotor FA-45-6-30 aerosol-tight*, aluminum, 45° angle, 6 places, for 15/50 mL conical tubes, incl. rotor lid (aluminum)
5820 716.002	5820716002	Rotor lid for FA-45-6-30 aerosol-tight, aluminum
5418 709.008	022652109	Seal for rotor lid FA-45-18-11 (5418/5418 R), FA-45-6-30 (5804/5804 R/5810/5810 R), FA-6×50 (5910 R, 5920 R, 5910 Ri) 5 pieces
5820 717.009 5820 720.000 5820 721.006 5820 722.002 5820 730.005 5820 726.008	5820717009 5820720000 5820721006 5820722002 5820730005 5820726008	Adapter used in rotor FA-45-6-30 for 1 conical tubes 15 mL (max. Ø 17 mm), set of 2 pieces for 1 Oak Ridge 16 mL (max. Ø 18 mm), set of 2 pieces for 1 Oak Ridge 30 mL (max. Ø 26 mm), set of 2 pieces for 1 Oak Ridge 35 mL (max. Ø 30 mm), set of 2 pieces for 1 tube 5 mL (max. Ø 17 mm), set of 2 pieces for 1 round-bottom and blood collection tube (13 mm × 75 mm), set of 2 pieces
5820 725.001	5820725001	for 1 round-bottom and blood collection tube (13 mm × 100 mm), set of 2 pieces

Order no. (International)	Order no. (North America)	Description
5820 728.000	5820728000	for 1 Oak Ridge 10 mL, round-bottom and blood collection tube (13 mm × 75 mm), set of 2 pieces
5820 727.004	5820727004	for 1 round-bottom and blood collection tube (16 mm × 100 mm), set of 2 pieces
5820 729.007	5820729007	for 1 round-bottom and blood collection tube (17,5 mm × 100 mm), set of 2 pieces

11.1.7 Rotor F-34-6-38

Order no. (International)	Order no. (North America)	Description
5804 727.002	022637207	Rotor F-34-6-38 34° angle, 6 places for 85 mL tubes, incl. rotor lid
5804 727.509	5804727509	Rotor lid for F-34-6-38
5804 770.005	022637215	Adapter used in F-34-6-38 for 4 sample tubes 1.5/2.0 mL (max. Ø 11 mm), set of 2
5804 777.000	5804777000	for 1 tube 5 mL (max. Ø 17 mm), set of 2 pieces
5804 738.004	022637279	for 3 round-bottom and blood collection tubes (13 × 75 mm), set of 2 pieces
5804 739.000	022637282	for 3 round-bottom and blood collection tubes (13 × 100 mm), set of 2 pieces
5804 771.001	022637223	for 2 tubes (7 bis 15 mL, max. Ø 16 mm), set of 2
5804 776.003	022637274	for 1 conical tube (15 mL, max. Ø 17 mm), set of 2
5804 772.008	022637231	for 1 tube (15 bis 18 mL, max. Ø 18 mm), set of 2
5804 773.004	022637240	for 1 tube (20 bis 30 mL, max. Ø 26 mm), set of 2
5804 774.000	022637258	for 1 tube (50 mL, max. Ø 29 mm), set of 2
5804 775.007	022637266	for 1 conical tube (50 mL, max. Ø 29.5 mm), set of 2

11.1.8 Rotor FA-45-30-11 and rotor F-45-30-11

Order no. (International)	Order no. (North America)	Description
5804 726.006	022637100	Rotor FA-45-30-11 aerosol-tight*, 45° angle, 30 places for 1.5/2.0 mL tubes, incl. rotor lid (aluminum)
5804 736.001	022637126	Rotor lid for FA-45-30-11 aerosol-tight, aluminum
5804 715.004	022637002	Rotor F-45-30-11 45° angle, 30 places for 1.5/2.0 mL tubes, incl. rotor lid (aluminum)
5804 715.403	022662970	Rotor lid for F-45-30-11 not aerosol-tight, aluminum

Ordering Information

Centrifuge 5804/5804 R Centrifuge 5810/5810 R
English (EN)

Order no. (International)	Order no. (North America)	Description
5425 715.005	022636260	Adapter used in FA-45-30-11 and F-45-30-11 for 1 PCR tube (0.2 mL, max. Ø 6 mm), set of 6 for 1 micro test tube (0.4 mL, max. Ø 6 mm), set of 6 for 1 sample tube (0.5 mL, max. Ø 6 mm) or 1 Microtainer (0.6 mL, max. Ø 8 mm), set of 6
5425 717.008	022636243	
5425 716.001	022636227	

11.1.9 Rotor F-45-48-PCR

Order no. (International)	Order no. (North America)	Description
5804 735.005	022638581	Rotor F-45-48-PCR 45° angle, for 6 × 8-tube strips, 6 × 5-tube strips or 48 × 0.2 mL PCR tubes

11.1.10 Rotor T-60-11

Order no. (International)	Order no. (North America)	Description
5804 730.003	5804730003	Rotor T-60-11 for 1.5/2.0 mL tubes, without adapter incl. rotor lid
5804 731.000	022638521	Adapter used in T-60-11 for 10 sample tubes (1,5/2,0 mL, max. Ø 11 mm), set of 6 for 20 sample tubes (0.4 mL, max. Ø 6 mm), set of 6
5804 732.006	022638548	

11.1.11 Rotor S-4-104

Order no. (International)	Order no. (North America)	Description
5820 740.000	5820740000	Rotor S-4-104 incl. 4 × 750 mL round buckets incl. 4 plate buckets (aerosol-tight capable) without buckets
5820 754.001	5820754001	
5820 755.008	5820755008	
5825 740.009	5825740009	Adapter used in rotor S-4-104 for 50 tubes 1,5 mL/2,0 mL (max. Ø 11 mm), set of 2 pieces for 14 tubes 5 mL (max. Ø 17 mL), set of 2 pieces for 23 round-bottom tubes and blood collection tubes (13 mm × 75 - 100 mm), set of 2 pieces for 20 round-bottom tubes and blood collection tubes (16 mm × 75 - 100 mm), set of 2 pieces
5825 739.000	5825739000	
5825 738.004	5825738004	
5825 736.001	5825736001	

Order no. (International)	Order no. (North America)	Description
5825 743.008	5825743008	for 20 round-bottom tubes and blood collection tubes (17,5 mm × 100 mm), set of 2 pieces
5825 734.009	5825734009	for 14 conical tubes 15 mL (max. Ø 17 mm), set of 2 pieces
5825 733.002	5825733002	for 7 conical tubes 50 mL (max. Ø 30 mm), set of 2 pieces
5825 732.006	5825732006	for 5 skirted conical tubes (max. Ø 30 mm), set of 2 pieces
5825 741.005	5825741005	für 1 tube 175 - 250 mL (max. Ø 62 mm), set of 2 pieces
5825 745.000	5825745000	for 1 Corning 500 mL Centrifuge Tube (max. Ø 96 mL), set of 2 pieces
5825 744.004	5825744004	for 1 wide-neck bottle 750 mL (max. Ø 102 mL), set of 2 pieces
5820 708.000	5820708000	Wide-neck bottle 750 mL, for rotor S-4-104, rotor S-4x750 750 mL, set of 2
5820 742.003	5820742003	Round bucket 750 mL for Rotor S-4-104 set of 2 pcs.
5820 741.007	5820741007	set of 4 pcs.
5820 744.006	5820744006	Plate bucket (aerosol-tight capable) for Rotor S-4-104, incl. plate carrier set of 2 pcs.
5820 743.000	5820743000	set of 4 pcs.
5820 758.007	5820758007	Plate bucket (open) for rotor S-4-104 set of 2
5820 757.000	5820757000	set of 4
5820 748.001	5820748001	Aerosol-tight cap Rotors S-4-104, S-4x750, Plate Bucket 2 pieces
5820 756.004	5820756004	Plate carrier Rotor S-4-104, S-4x750 2 pieces
5820 780.002	5820780002	Sealings for aerosol-tight caps Rotors S-4-104, S-4x750, S-4x1000, Plate/Tube Bucket 4 pieces
5820 747.005	5820747005	Aerosol-tight cap Rotors S-4-104, S-4x750, S-4x1000, round bucket 750 mL/ 1000 mL 2 pieces
5820 749.008	5820749008	Sealings for aerosol-tight caps Rotors S-4-104, S-4x750, S-4x1000, round bucket 750 mL/ 1000 mL 5 pieces
5810 718.309	022664174	Rotor key for Rotor A-4-81, S-4-104

Ordering Information

Centrifuge 5804/5804 R Centrifuge 5810/5810 R
English (EN)

11.1.12 Rotor S-4-72

Order no. (International)	Order no. (North America)	Description
5804 746.007	5804746007	Rotor S-4-72 incl. 4 × 250 mL round buckets
5804 794.001	5804794001	Adapter used in rotor S-4-72 for 26 tubes 1,5/2,0 mL (max. Ø 11 mm), set of 2 pieces
5804 793.005	5804793005	for 8 tubes 5 mL (max. Ø 17 mm), set of 2 pieces
5804 789.008	5804789008	for 14 round-bottom und blood collection tubes (13 mm × 75 - 100 mm), set of 2 pieces
5804 791.002	5804791002	for 13 round-bottom und blood collection tubes (16 mm × 75 - 100 mm), set of 2 pieces
5804 792.009	5804792009	for 12 round-bottom und blood collection tubes (17,5 mm × 100 mm), set of 2 pieces
5804 783.000	5804783000	for 8 conical tubes 15 mL (max. Ø 17 mm), set of 2 pieces
5804 784.006	5804784006	for 4 conical tubes 50 mL (max. Ø 30 mm), set of 2 pieces
5804 785.002	5804785002	for 2 conical tubes 15 mL, 50 mL (max. Ø 17 mm, Ø 30 mm), set of 2 pieces
5804 787.005	5804787005	for 1 tube 175 - 250 mL (max. Ø 62 mm), set of 2 pieces
5804 747.003	5804747003	Round bucket 250 mL for Rotor S-4-72 Set of 4 pcs.

11.1.13 Rotor F-35-48-17

Order no. (International)	Order no. (North America)	Description
5820 771.003	5820771003	Rotor F-35-48-17 for 24 × 15 mL conical tubes incl. 24 steel sleeves and adapters
5820 772.000	5820772000	Rotor F-35-48-17 for 40 × 15 mL conical tubes incl. 48 steel sleeves and adapters
5820 774.002	5820774002	Steel sleeves and adapter for vessels 15 mL for rotors F-35-48-17 (5804/5804 R/5810/5810 R) , F-48×15 (5910 R) (5804/5804 R/5810/5810 R) , F-48×15 (5910 R)

11.1.14 Rotor FA-45-48-11

Order no. (International)	Order no. (North America)	Description
5820 760.001	5820760001	Rotor FA-45-48-11 for 48 × 1.5/2.0 mL tubes, aerosol-tight incl. rotor lid
5820 761.008	5820761008	Rotor lid, aerosol-tight for rotor FA-45-48-11 1 piece
5820 767.006	5820767006	Seal for rotor lid FA-45-24-11-Kit (5427 R/530/5430 R), FA-45-48-11 (5427 R/ 5430/5430 R, 5804/5804 R/5810/5810 R), FA-30x2 (5910 R, 5920 R, 5910 Ri), FA-48x2 (5910 R, 5920 R, 5910 Ri) 5 pieces

11.1.15 Rotor FA-45-20-17

Order no. (International)	Order no. (North America)	Description
5820 765.003	5820765003	Rotor FA-45-20-17 for 20 Eppendorf Tubes 5.0 mL incl. rotor lid
5820 766.000	5820766000	Rotor lid, aerosol-tight for rotor FA-45-20-17 1 pieces
5409 718.002	5409718002	Seal for rotor lid FA-45-20-17 (5804/5804 R/5810/5810 R), FA-20x5 (5910 R, 5920 R, 5910 Ri) 5 pieces
5820 768.002 5820 769.009	5820768002 5820769009	Adapter used in rotor FA-45-12-17 (5427 R), FA-45-16-17 (5430/5430 R), FA-45-20-17 (5804/5804 R/5810/5810 R) for 1 tube 1,5 mL/2,0 mL (max. Ø 11 mm), set of 10 pieces for 1 Cryo tube, set of 4 pieces
5820 770.007	5820770007	Adapter used in Rotor FA-45-12-17 (5427 R), FA-45-16-17 (5430/5430 R), FA-45-20-17 (5804/5804 R/5810/5810 R) for 1 HPLC vial, set of 10 pieces

Ordering Information

Centrifuge 5804/5804 R Centrifuge 5810/5810 R
English (EN)

11.2 Accessories

Order no. (International)	Order no. (North America)	Description
5804 720.008	022639021	Rotor stand suitable for all rotors of Centrifuge 5804/5804 R/5810/5810 R
5810 350.050	022634330	Pivot grease Tube 20 mL
5810 350.018 5810 718.309	022664166 022664174	Rotor key Standard for Rotor A-4-81, S-4-104
5811 001.068	022662678	Tray for condensation water

12 Annex

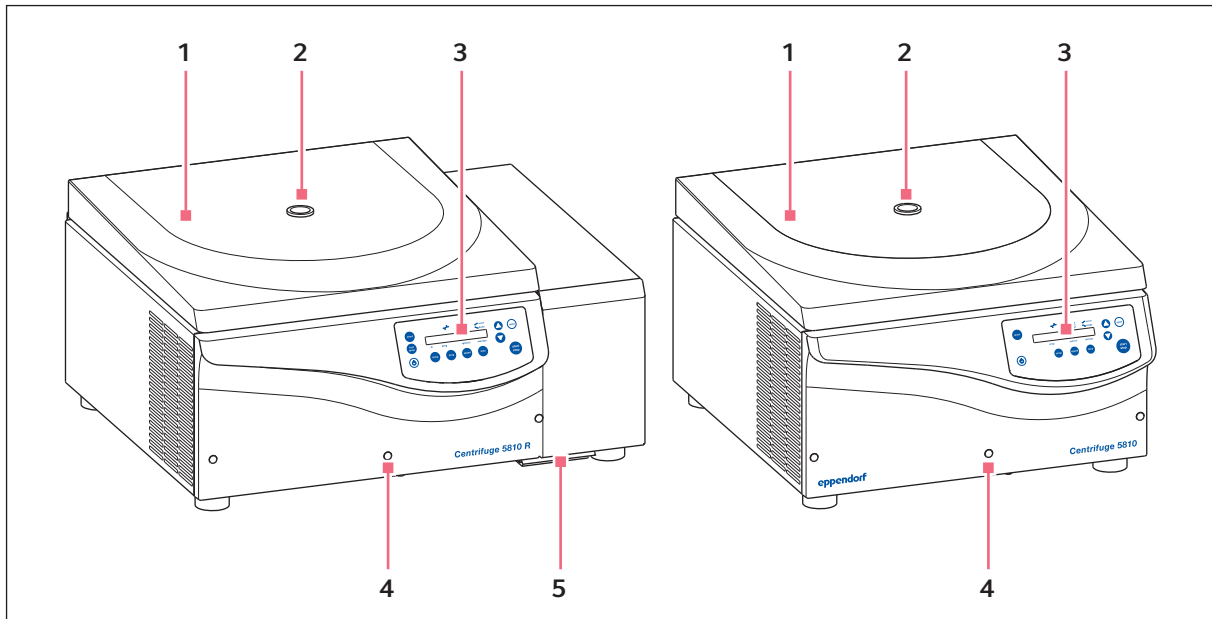


















Fig. 12-1: Centrifuge 5810 R and 5810. The Centrifuges 5804 R and 5804 are similar in design.

- | | |
|------------------------------|---|
| 1 Centrifuge lid | 4 Emergency release |
| 2 Monitoring glass | 5 Condensation water tray (Centrifuge 5804 R/
5810 R only) |
| 3 Control panel with display | |

Annex

Centrifuge 5804/5804 R Centrifuge 5810/5810 R
English (EN)

Task/function	Keys	Display
Set parameter	1. Press  or  etc. 2. Press  or  .	1. Selected parameter flashes. 2. New value appears.
Soft start/stop	1. Press  repeatedly. 2. Press  or  to select ramp.	 : Acceleration ramp 0 (long) ... 9 (short).  : Deceleration ramp 0 (long) ... 9 (short).
Alarm on/Alarm off	▶ Press  +  simultaneously.	<i>Alarm on/Alarm off</i>
Programming (during rotor stop only)	1. Set parameter. 2. Press 2 ×  . 3. Store: Press  > 2 s.	1. Parameters 2. P...: first idle program no. 3. OK
At set rpm (with open centrifuge lid only)	Press  > 4 s.	 : on  : off

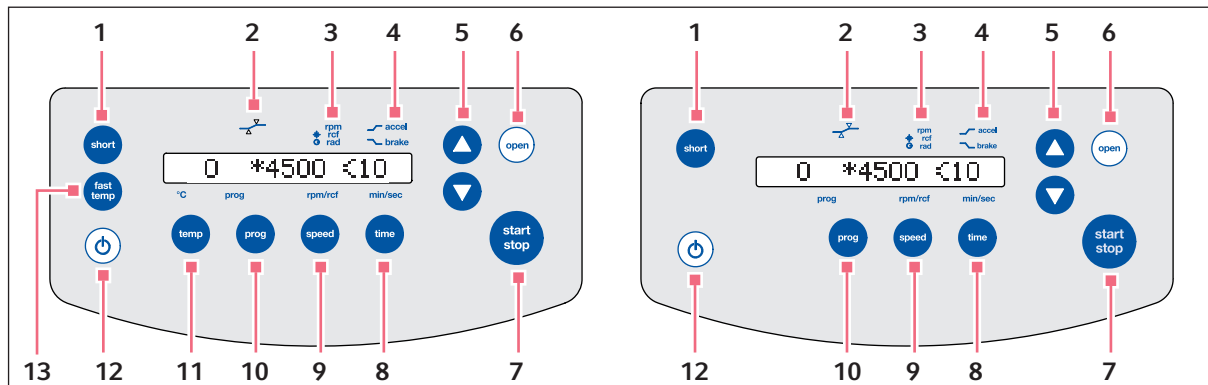


Fig. 12-2: Control panel of the Centrifuge 5804 R/5810 R and the Centrifuge 5804/5810.

- | | |
|---|--|
| <p>1 short key
Short spin centrifugation</p> <p>2 At set rpm function status</p> <p>3 speed (rpm), g-force (rcf) *, and radius setting
⊙ indicator</p> <p>4 Symbol for acceleration ↗ and braking ↘</p> <p>5 Arrow keys
Set parameter values</p> <p>6 open key
Release centrifuge lid</p> <p>7 start/stop key
Start or stop centrifugation</p> | <p>8 time key
Select run time setting</p> <p>9 speed key
Select speed setting</p> <p>10 prog key
Select or save program</p> <p>11 temp key
Centrifuge 5804 R/5810 R only: Select temperature setting</p> <p>12 Standby ⊙ key</p> <p>13 fast temp key
Centrifuge 5804 R/5810 R only: Start FastTemp temperature control run</p> |
|---|--|

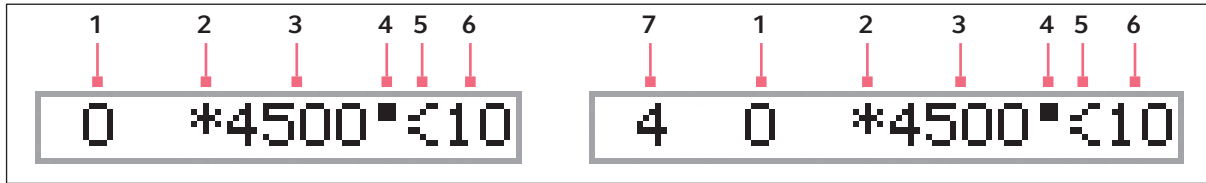


Fig. 12-3: Display of the Centrifuge 5804 R/5810 R and the Centrifuge 5804/5810

- | | |
|--|---|
| 1 Temperature (only 5804 R/5810 R) | 5 Symbol flashes when rotor is in motion |
| 2 Program number | 6 Symbol for acceleration ↗ and braking ↘ |
| 3 Symbol for <i>g</i> -force (rcf) | 7 Centrifugation time |
| 4 <i>g</i> -force (rcf)/rotational speed (rpm) | |

Rotor code:
All Eppendorf® rotors are identified using a simple, alphanumeric format that represents the technical specifications in a uniform series of letters and numbers.

<p>Fixed-angle rotor</p> <p>F A — 45 — 30 — 11</p> <p>Aerosol-tight version Number of bores</p>	<p>Angles of bores</p> <p>∅ of bores (mm)</p>	<p>Swing-bucket rotor</p> <p>S — 4 — 72</p> <p>Number of buckets</p>	<p>∅ of buckets (mm)</p>
--	---	---	--------------------------

Rotor code:
All Eppendorf® rotors are identified using a simple, alphanumeric format that represents the technical specifications in a uniform series of letters and numbers.

<p>Fixed-angle rotor</p> <p>F A — 45 — 30 — 11</p> <p>Aerosol-tight version Number of bores</p>	<p>Angle of bores</p> <p>∅ of bores (mm)</p>	<p>Swing-bucket rotor</p> <p>A — 4 — 81</p> <p>Number of buckets</p>	<p>∅ of buckets (mm)</p>
--	--	---	--------------------------

Declaration of Conformity

The product named below fulfills the requirements of directives and standards listed. In the case of unauthorized modifications to the product or an unintended use this declaration becomes invalid. This declaration of conformity is issued under the sole responsibility of the manufacturer.

Product name:

Centrifuge 5804, Centrifuge 5804 R, Centrifuge 5810, Centrifuge 5810 R

including components

Product type:

Centrifuge

Relevant directives / standards:

2006/42/EC: DIN EN ISO 12100 + Cor.1, DIN EN 378-2 (only 5804 R and 5810 R)

2014/35/EU: DIN EN 61010-1, DIN EN 61010-2-020

2014/30/EU: DIN EN 61326-1, DIN EN 55011

2011/65/EU: DIN EN IEC 63000
(incl. (EU) 2015/863)

Further applied standards: IEC 61010-1 + Cor. + A1 + A1/Cor.1, IEC 61010-2-020
UL 61010-1, UL 61010-2-020
CAN/CSA C22.2 No. 61010-1-12, CAN/CSA C22.2 No. 61010-2-020
IEC 61326-1, CISPR 11 + A1, 47 CFR FCC part 15
YY/T 0657, GB 4793.1, GB 4793.7, GB 18268.1, YY/T 0466.1, SJ/T 11364,
GB/T 26572

Person authorized to compile

the technical file acc. to 2006/42/EC: Dr. Marlene Jentzsch
Senior Vice President
Division Separation & Instrumentation
Eppendorf SE

Hamburg, November 09, 2021



Dr. Wilhelm Plüster
Management Board



Dr. Marlene Jentzsch
Senior Vice President
Division Separation & Instrumentation

Your local distributor: www.eppendorf.com/contact
Eppendorf SE · Barkhausenweg 1 · 22339 Hamburg · Germany
eppendorf@eppendorf.com

Eppendorf® and the Eppendorf Brand Design are registered trademarks of Eppendorf SE, Germany.
All rights reserved, incl. graphics and pictures. Copyright ©2021 by Eppendorf SE.

ISO
9001
Certified

ISO 13485
Certified

ISO 14001
Certified

CERTIFICATE OF COMPLIANCE

Certificate Number 2018-11-22-E215059
Report Reference E215059-D1013-1/A1/C0-UL
Issue Date 2018-11-22
Issued to: EPPENDORF A G
Applicant Company: BARKHAUSENWEG 1
22339 HAMBURG GERMANY
Listed Company: Same as Applicant

**This is to certify that
representative samples of**

Laboratory Centrifuge
5804, 5805T, 5805F, 5810, 5811T, 5811F

Have been investigated by UL in accordance with the
Standard(s) indicated on this Certificate.

Standard(s) for Safety:

UL 61010-1, 3rd Edition, May 11, 2012, Revised April 29 2016,
CAN/CSA-C22.2 No. 61010-1-12, 3rd Edition, Revision dated
April 29 2016

Additional Standards:

CSA CAN/CSA-C22.2 NO. 61010-2-020:17 - Particular
requirements for laboratory centrifuges - Third Edition - issue
date 2017-01-01
UL 61010-2-020:2016 - Particular requirements for laboratory
centrifuges - Third Edition - issue date 2016-12-15

Additional Information:

See the UL Online Certifications Directory at
www.ul.com/database for additional information.

Only those products bearing the UL Certification Mark should be considered as being covered by UL's
Certification and Follow-Up Service.

Recognized components are incomplete in certain constructional features or restricted in
performance capabilities and are intended for use as components of complete equipment submitted
for investigation rather than for direct separate installation in the field. The final acceptance of the
component is dependent upon its installation and use in complete equipment submitted to UL LLC.

Look for the UL Certification Mark on the product.

This is to certify that representative samples of the product as specified on this certificate were tested
according to the current UL requirements.

Bruce Mahrenholz *Joseph Hosey*

Bruce Mahrenholz, Assistant Chief Engineer, Global Inspection and Field Services, UL LLC
Joseph Hosey, General Manager, Director of Sales – Canada, UNDERWRITERS LABORATORIES OF CANADA INC.

Helena Y. Wolf

Helena Y. Wolf, Director, Global Market Access Operations, UL LLC

Any information and documentation involving UL Mark services are provided on behalf of UL LLC (UL) or any authorized licensee of UL. For questions, please contact a local UL
Customer Service Representative www.ul.com/contactus





Certificate of Containment Testing

Containment Testing of Swing Out Rotor with Buckets [A-2-DWP-AT (5820 710.004-00)] and Autoclaved (x50) lids in the Eppendorf Centrifuge 5810

Report No. 104-09 B

Report prepared for: Eppendorf AG, Hamburg, Germany
Issue Date: 31st March 2010 (amended 17th Aug 10)

Test Summary

Swing out rotor with buckets [A-2-DWP-AT (5820 710.004-00)] and autoclaved (x50) lids was containment tested in the Eppendorf 5810 centrifuge, in accordance with Annex AA of IEC 1010-2-20. The sealed bucket was shown to contain the spill of micro-organisms and therefore prevent any release.

Report Written By

A handwritten signature in blue ink, appearing to be "Alloc", written over a dashed horizontal line.

Report Authorised By

A handwritten signature in blue ink, written over a dashed horizontal line.



Certificate of Containment Testing

Containment Testing of Rotor A-4-44 and Sealed Buckets and Lids (Cap 100, Order no. 5804 712.005) in the Eppendorf Centrifuge 5810

Report No. 352-97 (Part 1)

Report prepared for: Eppendorf AG, Hamburg, Germany
Issue Date: Original report issued 8th September 1997
Certificate issued 18th October 2010

Test Summary

Rotor A-4-44 and sealed buckets and lids (Cap 100, Order no. 5804 712.005) were containment tested in the Eppendorf Centrifuge 5810, using Annex AA of IEC 1010-2-020. The sealed buckets were shown to contain the spill within the centrifuge.

Report Written By

Anna May

Report Authorised By

[Signature]

Health Protection Agency
Microbiological Services
Porton Down
Salisbury
Wiltshire SP4 0JG
United Kingdom



Certificate of Containment Testing

Containment Testing of Rotor A-4-62 and Sealed Buckets and Lids (Cap 250/1, Order no. 5810 710.006) in the Eppendorf Centrifuge 5810

Report No. 352-97 (Part 2)

Report prepared for: Eppendorf AG, Hamburg, Germany

Issue Date: Original report issued 8th September 1997

Certificate issued 18th October 2010

Test Summary

Rotor A-4-62 and sealed buckets and lids (Cap 250/1, Order no. 5810 710.006) were containment tested in the Eppendorf Centrifuge 5810, using Annex AA of IEC 1010-2-020. The sealed buckets were shown to contain the spill within the centrifuge.

Report Written By

Anna May

Report Authorised By

[Signature]

Certificate of Containment Testing

400ml Rectangular Buckets fitted with Sealed Caps in Eppendorf Centrifuge 5810 containing Rotor A-4-81

Report No. 1000-06

Report prepared for: Eppendorf AG, Hamburg, Germany
Issue Date: 21st March 2006

Test Summary

400 ml rectangular buckets fitted with sealed caps were containment tested in the Eppendorf centrifuge 5810 containing rotor A-4-81, using Annex AA of IEC 1010-2-20. The buckets were shown to contain a large spill.

Report Written By



Report Authorised By





Certificate of Containment Testing

Containment Testing of Rotor FA-45-6-30 [(5820 715.103-00) and autoclaved lid (x50)] in the Eppendorf Centrifuge 5810R

Report No. 40-10B

Report prepared for: Eppendorf AG, Hamburg, Germany
Issue Date: 19th July 2010 (amended 17th Aug 10)

Test Summary

Rotor FA-45-6-30 (5820 715.103-00) and autoclaved lid (x50) was containment tested in the Eppendorf centrifuge 5810R, in accordance with Annex AA of IEC 1010-2-20. The sealed rotor was shown to contain the spill of micro-organisms and therefore prevent any release.

Report Written By

A handwritten signature in blue ink, appearing to be "Hla", written over a horizontal dashed line.

Report Authorised By

A handwritten signature in blue ink, appearing to be "A. J. ...", written over a horizontal dashed line.



Certificate of Containment Testing

Containment Testing of Rotor FA-45-20-17 (5820 765.100-00) in the Eppendorf 5810/R Bench Top Centrifuge

Report No. 35/13

Report Prepared For: Eppendorf AG, Hamburg, Germany

Issue Date: 24th April 2013

Test Summary

Rotor FA-45-20-17 (5820 765.100-00) was containment tested in the Eppendorf 5810/R bench top centrifuge, using Annex AA of IEC 61010-2-020:2006 (2nd Ed.). The sealed rotor was shown to contain a spill within the centrifuge.

Report Written By

Name: Miss Anna Moy

Title: Biosafety Scientist

Report Authorised By

Name: Mrs Sara Speight

Title: Senior Biosafety Scientist



Certificate of Containment Testing

Containment Testing of Rotor FA-45-48-11(5820 760.109-00) in the Eppendorf 5810/R Bench Top Centrifuge

Report No. 199-12

Report Prepared For: Eppendorf AG, Hamburg, Germany

Issue Date: 12th September 2012

Test Summary

Rotor FA-45-48-11 (5820 760.109-00) was containment tested in the Eppendorf 5810/R bench top centrifuge, using Annex AA of IEC 1010-2-20. The sealed rotor was shown to contain a spill within the centrifuge

Report Written By

A handwritten signature in blue ink that reads "Anna Moy".

Name: Miss Anna Moy

Title: Biosafety Scientist

Report Authorised By

A handwritten signature in blue ink that reads "Sara Speight".

Name: Mrs Sara Speight

Title: Senior Biosafety Scientist



Certificate of Containment Testing

Containment Testing of Rotor S-4-104 with Round Buckets (5820 741.007-00) in the Eppendorf 5810/R Bench Top Centrifuge

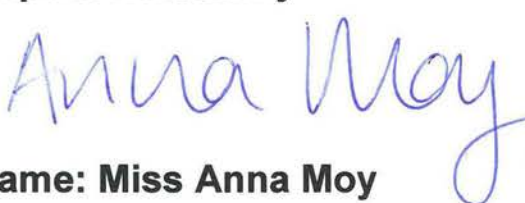
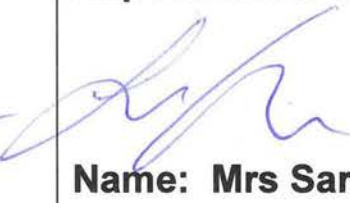
Report No. 196-12 A

Report Prepared For: Eppendorf AG, Hamburg, Germany

Issue Date: 12th September 2012

Test Summary

Rotor S-4-104 with Round Buckets (5820 741.007-00) was containment tested in the Eppendorf 5810/R bench top centrifuge, using Annex AA of IEC 1010-2-20. The sealed rotor was shown to contain a spill within the centrifuge

Report Written By  Name: Miss Anna Moy Title: Biosafety Scientist	Report Authorised By  Name: Mrs Sara Speight Title: Senior Biosafety Scientist
--	--



Certificate of Containment Testing

Containment Testing of Caps for Rotor S-4-104 with DWP- Buckets in the Eppendorf 5810/R Bench Top Centrifuge

Report No. 111/13 A

Report Prepared For: Eppendorf AG, Hamburg, Germany
Issue Date: 10th April 2014

Test Summary

Caps for rotor S-4-104 with DWP-Buckets were containment tested in the Eppendorf 5810/R bench top centrifuge, using Annex AA of IEC 61010-2-020:2006 (2nd Ed.). The sealed rotor was shown to contain a spill within the centrifuge.

Report Written By

Name: Miss Anna Moy
Title: Biosafety Scientist

Report Authorised By

Name: Mrs Sara Speight
Title: Senior Biosafety Scientist

Evaluate Your Manual

Give us your feedback.
www.eppendorf.com/manualfeedback