

Instructions For Use

Allegra X-30 Series

Centrifuges



B01145AA
April 2011



Beckman Coulter, Inc.
250 S. Kraemer Blvd.
Brea, CA 92821



Allegra X-30 Series
Centrifuges
B01145AA (April 2011)

Copyright © 2011 Beckman Coulter, Inc.

All rights reserved. No part of this document may be reproduced or transmitted in any form or by any means, electronic, mechanical, photocopying, recording, or otherwise, without prior written permission from Beckman Coulter, Inc.

Find us on the World Wide Web at:

www.beckmancoulter.com

EC	REP
----	-----

Beckman Coulter Ireland, Inc.
Mervue Business Park, Mervue Galway, Ireland 353 91 774068

Beckman Coulter do Brasil Com e Imp de Prod de Lab Ltda
Estr dos Romeiros, 220 - Galpao G3 - Km 38.5
06501-001 - Sao Paulo - SP - Brasil
CNPJ: 42.160.812/0001-44

製造販売元：ベックマン・コールター株式会社
東京都江東区有明三丁目 5 番 7 号
TOC 有明ウエストタワー

贝克曼库尔特有限公司，
美国加利福尼亚州，Brea 市，S. Kraemer 大街 250
号，

CHAPTER 1: Safety, 1-1

Alerts for Danger, Warning, Caution, Important, and Note, 1-1

Safety During Installation and/or Maintenance, 1-2

Electrical Safety, 1-2

Safety Against Risk of Fire, 1-2

Mechanical Safety, 1-2

Chemical and Biological Safety, 1-3

CHAPTER 2: Introduction, 2-1

Intended Use, 2-1

Certification, 2-1

Scope, 2-2

Typographic Conventions, 2-2

CFC-Free Centrifugation, 2-2

Radio Interference, 2-3

Canadian Regulations, 2-3

Recycling Label, 2-3

Nonrefrigerated Model Specifications, 2-4

Refrigerated Model Specifications, 2-5

Available Rotors, 2-6

CHAPTER 3: Description, 3-1

Introduction, 3-1

Instrument Function and Safety Features, 3-1

Instrument Function, 3-1

Models, 3-2

Safety Features, 3-2

Name Rating Plate, 3-2

Chassis, 3-2

- Housing, 3-2
- Door, 3-3
- Rotor Chamber, 3-3
- Drive, 3-3

Temperature Sensing and Control (refrigerated models only), 3-4

- Controls and Indicators, 3-4
 - Power Switch, 3-4
 - Control Panel, 3-5

CHAPTER 4: Installation, 4-1

- Introduction, 4-1
- Installing the Instrument, 4-1
- Transportation Safety Devices, 4-2
- Electrical Requirements, 4-2
- Test Run, 4-4

CHAPTER 5: Operation, 5-1

- Introduction, 5-1
- Run Procedure, 5-2
 - Preparation and Loading, 5-2
 - Entering Run Parameters, 5-5
 - Starting a Run, 5-9
 - Pulse Function, 5-10
 - Changing Parameters During a Run, 5-11
 - Stopping a Run, 5-11
- Unloading, 5-12
- Disabling the Audible Tones, 5-12
- Summary of Run Procedures, 5-13

CHAPTER 6: Troubleshooting, 6-1

- Introduction, 6-1
- User Messages, 6-1
- Other Possible Problems, 6-3
- Emergency Access, 6-4

CHAPTER 7: Care and Maintenance, 7-1

- Introduction, 7-1
- Maintenance, 7-1
 - Preventive Maintenance, 7-1
 - Replacing the Rotor Chamber Gasket, 7-2

Cleaning, 7-3

Tube Breakage, 7-3

Decontamination, 7-4

Sterilization and Disinfection, 7-4

Storage and Transport, 7-4

Storage, 7-4

Returning a Centrifuge, 7-4

Supply List, 7-5

Replacement Parts, 7-5

Other, 7-5

Beckman Coulter, Inc.

Allegra X-30 Series Centrifuge Warranty

Illustrations

- 3.1 Interior View of the Rotor Chamber, 3-3
- 3.2 The Power Switch, 3-4
- 3.3 System Panels, 3-5
- 3.4 System Keys, 3-5
- 3.5 Program Keys, 3-6
- 3.6 Digital Displays, 3-8
- 4.1 Dimensions of the Refrigerated and Nonrefrigerated Centrifuges, 4-3
- 5.1 Tapered Sleeve Position, 5-2
- 5.2 Default Parameters, 5-6
- 6.1 Screw Locations, 6-4
- 6.2 Internal Access, 6-5
- 7.1 Replacing the Rotor Chamber Gasket, 7-2

Tables

5.1	Acceleration/Deceleration Times (in minutes:seconds), 5-9
6.1	Error Message Chart, 6-2
6.2	Troubleshooting Chart, 6-3

Read all product manuals and consult with Beckman Coulter-trained personnel before attempting to operate instrument. Do not attempt to perform any procedure before carefully reading all instructions. Always follow product labeling and manufacturer's recommendations. If in doubt as to how to proceed in any situation, contact your Beckman Coulter Representative.

Alerts for Danger, Warning, Caution, Important, and Note

DANGER

DANGER indicates an imminently hazardous situation which, if not avoided, will result in death or serious injury.

WARNING

WARNING indicates a potentially hazardous situation which, if not avoided, could result in death or serious injury. May be used to indicate the possibility of erroneous data that could result in an incorrect diagnosis.

CAUTION

CAUTION indicates a potentially hazardous situation, which, if not avoided, may result in minor or moderate injury. It may also be used to alert against unsafe practices. May be used to indicate the possibility of erroneous data that could result in an incorrect diagnosis.

IMPORTANT **IMPORTANT** is used for comments that add value to the step or procedure being performed. Following the advice in the Important adds benefit to the performance of a piece of equipment or to a process.

NOTE **NOTE** is used to call attention to notable information that should be followed during installation, use, or servicing of this equipment.

Safety During Installation and/or Maintenance

These centrifuges each weigh 48 kg/106 lb (nonrefrigerated model) or 78 kg/172 lb (refrigerated model). DO NOT attempt to lift or move one of them without assistance from another person.

Any servicing of this equipment that requires removal of any covers can expose parts which involve the risk of electric shock or personal injury. Make sure that the power switch is turned off and the instrument is disconnected from the main power source by removing its power plug from the receptacle, and refer such servicing to qualified personnel.

Do not replace any centrifuge components with parts not specified for use on this instrument.

Electrical Safety

To reduce the risk of electrical shock, this equipment uses a three-wire electrical cord and plug to connect this equipment to earth-ground. To preserve this safety feature:

- Make sure that the matching wall outlet receptacle is properly wired and earth-grounded. Check that the line voltage agrees with the voltage listed on the name-rating plate affixed to the instrument.
- Never use a three-to-two wire plug adapter.
- Never use a two-wire extension cord or a two-wire non-grounding type of multiple-outlet receptacle strip.

Do not place containers holding liquid on or near the chamber door. If they spill, liquid may get into the instrument and damage electrical or mechanical components.

Safety Against Risk of Fire

This centrifuge is not designed for use with materials capable of developing flammable or explosive vapors. Do not centrifuge such materials (chloroform or ethyl alcohol for example) in this instrument nor handle or store them within the 30-cm (1-ft) clearance envelope surrounding the centrifuge.

Mechanical Safety

For safe operation of the equipment, observe the following:

- Use only the Beckman Coulter rotors and accessories designed for use in this centrifuge.
- Before starting the centrifuge, make sure that the rotor tie-down screw is securely fastened.
- Do not exceed the maximum rated speed of the rotor in use.
- NEVER attempt to slow or stop the rotor by hand.

- Do not lift or move the centrifuge while the rotor is turning.
- If a glass tube breaks inside the chamber bowl, be careful when examining or cleaning the gasket or chamber, as sharp glass fragments may be embedded in their surfaces.
- NEVER attempt to override the door interlock system while the rotor is spinning.
- Maintain a 7.6-cm (3-in.) clearance envelope around the centrifuge while it is running. During operation you should come within the envelope only to adjust instrument controls, if necessary. Never bring any flammable substances within the 30-cm (1-ft) area surrounding the centrifuge. Never lean on the centrifuge or place items on the centrifuge while it is operating.

Chemical and Biological Safety

Normal operation may involve the use of solutions and test samples that are pathogenic, toxic, or radioactive. Such materials should not be used in this instrument, however, unless all necessary safety precautions are taken.

- Observe all cautionary information printed on the original solution containers prior to their use.
- Because spills may generate aerosols, observe proper safety precautions for aerosol containment.
- Handle all infectious samples according to good laboratory practices and methods to prevent the spread of disease. Ask your laboratory safety officer to advise you about the level of containment required for your application and about the proper decontamination or sterilization procedures to follow if fluids escape from containers. Biosafe containment should be used when Risk Group II materials (as identified in the World Health Organization *Laboratory Biosafety Manual*) are handled; materials of a higher group require more than one level of protection. Because spills may generate aerosols, observe proper safety precautions for aerosol containment.
- Other infectious samples must also be handled according to good laboratory procedures and methods to prevent spread of disease.
- Dispose of all waste solutions according to appropriate environmental health and safety guidelines.

It is your responsibility to decontaminate the instrument and accessories before requesting service by Beckman Coulter Field Service.

Introduction

Intended Use

This Allegra X-30 centrifuge is intended for use as a general purpose laboratory instrument for the separation of components through the use of relative centrifugal force. Applications may include the separation of chemicals, industrial or environmental samples, and bodily fluids such as blood and urine, either alone or after the addition of reagents or other additives.

This centrifuge should be operated by qualified personnel only.

Certification

To ensure full system quality, Beckman Coulter Allegra X-30 Series centrifuges have been manufactured in a registered ISO 9001:2008 or ISO 13485:2003 facility. They have been designed and tested to be compliant (when used with Beckman Coulter rotors) with the laboratory equipment requirements of applicable regulatory agencies. Declarations of conformity and certificates of compliance are available at www.beckmancoulter.com.

International symbols that may be displayed on the centrifuge are illustrated and described on the inside of the back cover page.

Scope

This manual is designed to familiarize you with the Beckman Coulter Allegra X-30 Series benchtop centrifuges, their functions, specifications, operation, and routine operator care and maintenance.

- The following introductory pages contain the instrument specifications, as well as space, electrical, and temperature conditions required for optimal centrifuge performance. A list of available rotors is also included.
- [CHAPTER 3, *Description*](#) provides a brief physical and functional description of the centrifuge and the operating controls and indicators.
- [CHAPTER 4, *Installation*](#) contains instructions for installing and connecting the centrifuge.
- Procedures for operating the centrifuge are summarized in [CHAPTER 5, *Operation*](#).
- [CHAPTER 6, *Troubleshooting*](#) lists possible error messages and/or malfunctions, together with probable causes and corrective actions required.
- Procedures for operator care and maintenance are presented in [CHAPTER 7, *Care and Maintenance*](#), as well as a brief list of supplies and replacement parts.

We recommend that you read this entire manual, especially [CHAPTER 1, *Safety*](#) and all safety-related information, before operating the centrifuge or performing instrument maintenance.

NOTE If the centrifuge is used in a manner other than specified in this manual, the safety and performance of this equipment could be impaired. Further, the use of any equipment other than that intended for use by Beckman Coulter has not been evaluated for safety. Use of any equipment not specifically recommended in this manual is the sole responsibility of the user.

Typographic Conventions

Certain typographic conventions are used throughout this manual to distinguish names of user interface components, such as keys and displays.

- *Key names* (for example, **START** or **ENTER**) and *display names* (for example, **TEMP°C** or **SPEED**) appear in bold type.
- *Cursor keys*, used to increment values up or down when setting parameters, are shown as up and down arrows (▲ or ▼).

CFC-Free Centrifugation

To ensure minimal environmental impact, no CFCs are used in the manufacture or operation of Allegra X-30 Series centrifuges.

Radio Interference

This instrument has been tested and found to comply with the limits for a Class A digital device, pursuant to Part 15 of FCC Rules. These limits are designed to provide reasonable protection against harmful interference when the equipment is operated in a commercial environment. This equipment generates, uses, and can radiate radio frequency energy and, if not installed and used in accordance with this instruction manual, may cause interference to radio communications. Operation of this equipment in a residential area may cause interference, in which case the user will be required to correct the interference at his or her own expense.

Canadian Regulations

This digital apparatus does not exceed the Class A limits for radio noise emissions from digital apparatus as set out in the radio interference regulations of the Canadian Department of Communications.

Le présent appareil numérique n'émet pas de bruits radioélectriques dépassant les limites applicables aux appareils numériques de Classe A prescrites dans le règlement sur le brouillage radioélectrique édicté par le Ministère des Communications du Canada.

Recycling Label

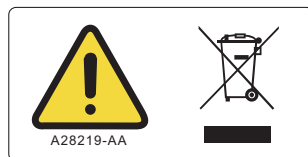

This symbol is required in accordance with the Waste Electrical and Electronic Equipment (WEEE) Directive of the European Union. The presence of this marking on the product indicates:

1. the device was put on the European market after August 13, 2005 and
2. the device is not to be disposed via the municipal waste collection system of any member state of the European Union.

It is very important that customers understand and follow all laws regarding the proper decontamination and safe disposal of electrical equipment. For Beckman Coulter products bearing this label please contact your dealer or local Beckman Coulter office for details on the take back program that will facilitate the proper collection, treatment, recovery, recycling and safe disposal of the device.

Nonrefrigerated Model Specifications

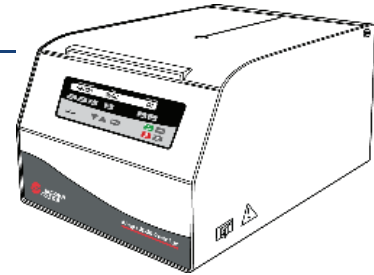

Only values with tolerances or limits are guaranteed data. Values without tolerances are informative data, without guarantee.

Speed Set speed Speed control Speed display	to 16,000 rpm (in 100-rpm increments) actual rotor speed, ± 50 rpm of set speed actual rotor speed in 100-rpm increments <i>or</i> in RCF (when selected)
Time Set time Time display	to 9 hr 59 min <i>or</i> continuous (∞) time remaining in run (timed run ± 1 minute) <i>or</i> ∞ and elapsed time (continuous run)
Acceleration	10 acceleration profiles
Deceleration	10 deceleration profiles
Ambient temperature range	4 to 35°C
Humidity restrictions	<80% (noncondensing)
Dimensions Width Depth Height, door closed Height, door open	46 cm (18.1 in.) 55 cm (21.7 in.) 35.5 cm (14.0 in.) 78.7 cm (31.0 in.)
Weight	48 kg (106 lb)
Clearances (sides)	7.6 cm (3.0 in.)
Electrical requirements 120-V instrument 100-V instrument 220–240-V instrument	120 VAC, 6 A, 60 Hz 100 VAC, 7 A, 50–60 Hz 220–240 VAC, 2.6 A, 50–60 Hz
Electrical supply	Class I
Maximum heat dissipation into room under steady-state conditions	1638 Btu/h (0.48 kW)
Noise level 0.91 m (3 ft) in front of instrument (approx.)	≤ 68 dBa
Installation (overvoltage) category	II
Pollution degree	2 ^a

a. Normally only nonconductive pollution occurs; occasionally, however, a temporary conductivity caused by condensation must be expected.

Refrigerated Model Specifications

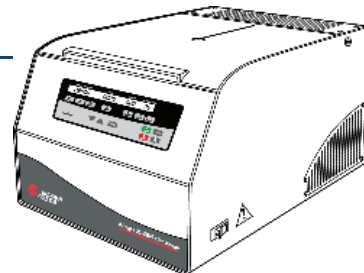

Only values with tolerances or limits are guaranteed data. Values without tolerances are informative data, without guarantee.





Speed Set speed Speed control Speed display	to 18,000 rpm (in 100-rpm increments) actual rotor speed, ± 50 rpm of set speed actual rotor speed in 100-rpm increments or in RCF (when selected)
Time Set time Time display	to 9 hr 59 min or continuous (∞) time remaining in run (timed run ± 1 min accuracy) or ∞ and elapsed time (continuous run)
Temperature Set temperature Temperature control (after equilibration) Temperature display (after equilibration) Operating range Ambient temperature range	-20 to $+40^{\circ}\text{C}$ (in 1°C increments) $\pm 2.5^{\circ}\text{C}$ of set temperature chamber temperature in 1°C increments 2 to $40^{\circ}\text{C}^{\text{a}}$ 10 to 35°C
Acceleration	10 acceleration profiles
Deceleration	10 deceleration profiles
Ambient temperature range	10 to 35°C
Humidity restrictions	$<80\%$ (noncondensing)
Dimensions Width Depth Height, door closed Height, door open	46 cm (18.1 in.) 70.7 cm (27.8 in.) 37 cm (14.6 in.) 81.3 cm (32.0 in.)
Weight	78 kg (172 lb)
Clearances (sides)	7.6 cm (3.0 in.)
Electrical requirements 120-V instrument 100-V instrument 220–240-V instrument	120 VAC, 11.5 A, 60 Hz 100 VAC, 12.6 A, 50–60 Hz 220–240 VAC, 6.2 A, 50–60 Hz
Electrical supply	Class I
Maximum heat dissipation into room under steady-state conditions	3311 Btu/h (0.97 kW)
Noise level 0.91 m (3 ft) in front of instrument (approx.)	≤ 68 dBa
Installation (overvoltage) category	II
Pollution degree	2 ^b

a. Temperature range depends on rotor in use and speed (see applicable rotor manual).

b. Normally only nonconductive pollution occurs; occasionally, however, a temporary conductivity caused by condensation must be expected.

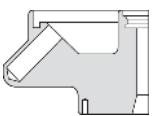
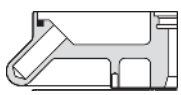
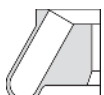
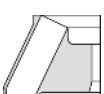
Available Rotors

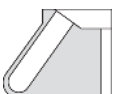
See the applicable rotor manual for information on rotor use, care and maintenance, and rotor accessories.

Rotor Profile	Description	Refrigerated		Nonrefrigerated		Max Capacity (mL)	Rotor Part Number/ Rotor Manual Number
		Max RPM	Max RCF ($\times g$)	Max RPM	Max RCF ($\times g$)		
	F2402H ^a Fixed Angle 45° Angle $r_{\max} = 82$ mm	18,000	29,756	16,000	23,511	24 \times 1.5/2.0	361171 GS-TB-021
	FX301.5 Fixed Angle 45° Angle $r_{\max} = 100$ mm	16,000	28,672	13,200	19,515	30 \times 1.5/2.0	392274 MMR-TB-002
	F0630 Fixed Angle 30° Angle $r_{\max} = 78$ mm	18,000	28,305	16,000	22,364	6 \times 30	361231 GS-TB-014
	F0850 Fixed Angle 25° Angle $r_{\max} = 94$ mm	11,400	13,682	9000	8528	8 \times 50	346640 GS-TB-003
	F0685 Fixed Angle 25° Angle $r_{\max} = 97$ mm	10,000	10,864	8000	6953	6 \times 85	364650 GS-TB-008
	F1010 Fixed Angle 35° Angle $r_{\max} = 76$ mm	18,000	27,579	16,000	21,791	10 \times 10	361221 GS-TB-007
	C0650 (Conical) Fixed Angle 25° Angle $r_{\max} = 92$ mm	10,000	10,304	9000	8346	6 \times 50	364670 GS-TB-009
	C1015 (Conical) Fixed Angle 25° Angle $r_{\max} = 93$ mm	10,000	10,416	9000	8437	10 \times 15	364680 GS-TB-011

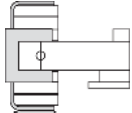
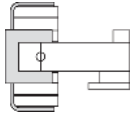
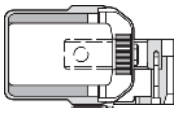
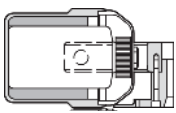
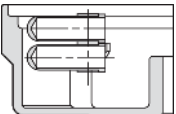
Rotor Profile	Description	Refrigerated		Nonrefrigerated		Max Capacity (mL)	Rotor Part Number/ Rotor Manual Number
		Max RPM	Max RCF ($\times g$)	Max RPM	Max RCF ($\times g$)		
	S2096 Microtiter $r_{\max} = 110$ mm	3000	1109	3000	1109	6 ea. 96 \times 0.3 mL 2 ea. 96 \times 2 mL	361111 GS-TB-005
	S6096 Microtiter $r_{\max} = 110$ mm	4700	2721	4700	2721	6 ea. 96 \times 0.3 mL 2 ea. 96 \times 2 mL	B01430
	SX4250 Swinging Bucket $r_{\max} = 172$ mm	4500	3901	4200	3398	4 \times 250	392243 GS22-TB-002
	SX4400 ^a Swinging Bucket $r_{\max} = 172$ mm	4700	4255	4200	3398	4 \times 400	B01425
	SX241.5 Swinging Bucket $r_{\max} = 74$ mm	14,000	16,244	12,500	12,950	24 \times 1.5/2.0	392271 MMR-TB-003

a. Certified for biocontainment by Porton Down U.K.

Description

Introduction

This chapter provides a brief physical and functional description of the Beckman Coulter Allegra X-30 Series centrifuges. The operating controls and indicators are also described; instructions for their use are in [CHAPTER 5, Operation](#). Chemical compatibilities of materials listed in this manual can be found in Chemical Resistances (publication IN-175). Refer to the applicable rotor manuals for rotor descriptions.

Instrument Function and Safety Features

Instrument Function

The Beckman Coulter Allegra X-30 Series benchtop centrifuges generate centrifugal forces required for a wide variety of applications. Together with any of several Beckman Coulter rotors designed specifically for use in these centrifuges, the instrument applications include:

- Routine processing such as sample preparations, pelleting, extractions, purifications, concentrations, phase separations, receptor binding, and column centrifugations.
- Processing large numbers of small-volume samples in multiwell plates for concentrating tissue-culture cells, cloning and replicate studies, *in-vitro* cytotoxicity studies, receptor binding, and genetic engineering experimentation.
- Rapid sedimentation of protein precipitates, large particles, and cell debris.
- Binding studies and separation of whole blood.
- Cell isolation.

The centrifuges are microprocessor-controlled, providing interactive operation. The instrument design features a brushless three-phase drive system, automatic rotor overspeed identification system, and a choice of acceleration/deceleration rates. The refrigerated models also have temperature control systems. User messages and a series of audible tones alert the operator to conditions that may need attention. (Instructions for disabling the audible tones are in [CHAPTER 4, Installation](#).)

Models

The centrifuge is available in both nonrefrigerated and refrigerated models. See [Nonrefrigerated Model Specifications](#) or [Refrigerated Model Specifications](#) in the [Introduction](#) for the operating differences between the two models. Unless indicated otherwise, information in this manual is the same for both models.

Safety Features

Allegra X-30 Series centrifuges have been designed and tested to operate safely indoors at altitudes up to 2000 m (6562 ft).

Instrument safety features include:

- The door has an electromechanical door-locking mechanism to prevent operator contact with spinning rotors. When the door is closed it locks automatically. It can be unlocked only by pressing the **OPEN DOOR** key, and opened only when the power is on and the rotor is at rest. Two independent monitoring systems prevent the door from opening if the rotor is spinning.
- A steel barrier surrounds the rotor chamber to provide full operator protection.
- An overspeed system continuously monitors the rotor during centrifugation. The system includes a magnetic sensor on the drive motor and magnets embedded in the rotors. Throughout the run, checks are made to ensure that the rotor does not exceed set speed.
- An imbalance detector monitors the rotor during the run, causing automatic shutdown if rotor loads are severely out of balance. At low speeds, an incorrectly loaded rotor can cause imbalance. Rotor instability can also occur if the centrifuge is moved while running, or if it is not resting on a level surface.
- The centrifuge feet, made of rubber, have been designed to minimize possible rotation in the event of a rotor mishap.

Name Rating Plate

The name rating plate is affixed to the rear of the centrifuge. Check that the line voltage agrees with the voltage listed on this name rating plate before connecting the centrifuge. Always mention the serial number and the model number shown when corresponding with Beckman Coulter regarding your centrifuge.

Chassis

Housing

The centrifuge housing is made of sheet steel, finished with urethane paint. The control panel is covered by a protective overlay made of coated polycarbonate.

Door

The door is made of a solid sheet of steel, encased in foam molding. In the center of the door is a window for strobe viewing. The door is secured to the housing by solid shafts. An electromechanical door lock system prevents operator contact with spinning rotors and prevents run initiation unless the door is shut and latched. The door is locked when a run is in progress and can be opened only when the rotor is stopped. (A light-emitting diode [LED] on the **OPEN DOOR** key lights up when the door can be opened.) In the event of a power failure, the door lock can be manually released for sample recovery (see [CHAPTER 6, Troubleshooting](#)).

Rotor Chamber

The rotor chamber is shown in [Figure 3.1](#). The drive shaft, mounting plate, rubber boot surrounding the drive shaft, thermistor, and rotor detector are visible in the chamber bottom. A gasket system around the chamber opening ensures sealing. (Instrument gaskets have not been designed as bioseals for aerosol containment.)

Figure 3.1 Interior View of the Rotor Chamber

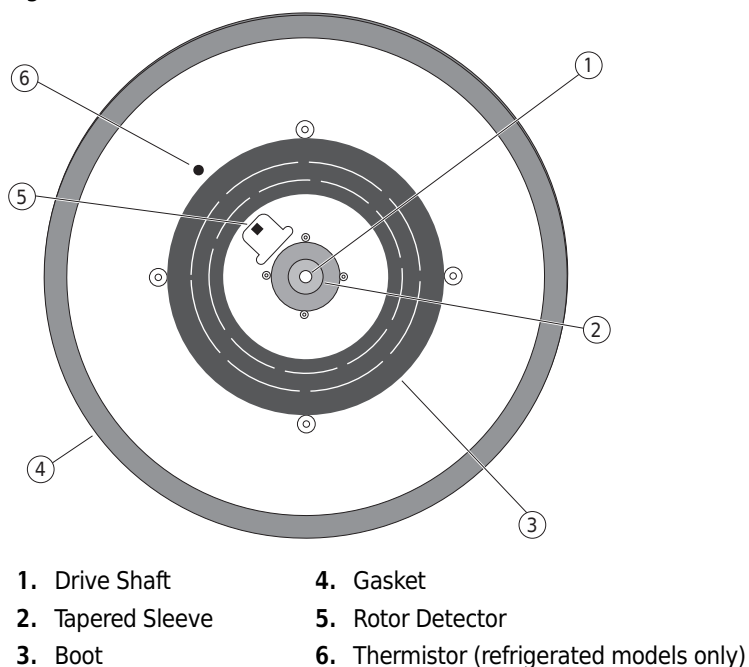

Drive

The asynchronous three-phase direct-drive motor is brushless for clean, quiet operation. A tie-down screw is used to attach the rotor to the drive shaft. The resilient suspension ensures that loads are not disturbed by vibration, and prevents damage to the drive shaft if an imbalance occurs during centrifugation. Maximum braking may be selected to reduce deceleration time, allowing fast processing of samples; alternately, delicate gradients may be preserved using slower deceleration.

Description

Temperature Sensing and Control (refrigerated models only)

Temperature Sensing and Control (refrigerated models only)

With the power on, the temperature control system is activated when the door is closed. The run temperature can be set between -20 and $+40^{\circ}\text{C}$ in refrigerated models. If no set temperature is entered, the centrifuge automatically selects the last entered temperature. (For the first run of a new centrifuge, the instrument selects 20°C as its operating temperature.) A thermistor in the rotor chamber continuously monitors chamber temperature. The micro-processor calculates the required chamber temperature to maintain the selected rotor temperature.

NOTE In the unlikely event of a complete cooling system failure, the drive switches off if the chamber temperature goes above 50°C . Restarting the centrifuge is not possible until the chamber is cooled.

Controls and Indicators

Power Switch

The power switch is located on the centrifuge right side panel (see [Figure 3.2](#)). This two-position rocker switch (**I**, on; **O**, off) controls electrical power to the centrifuge.

Figure 3.2 The Power Switch

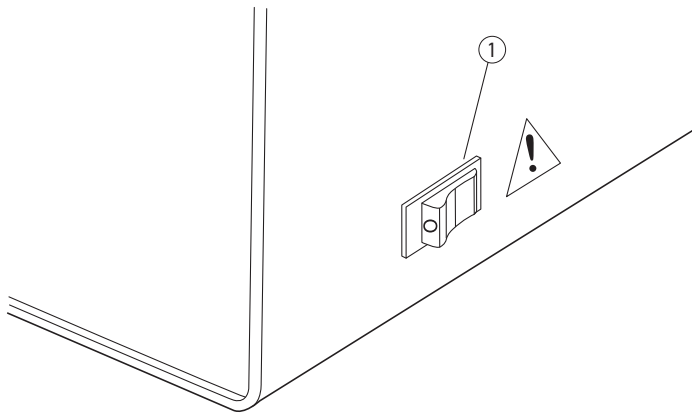

1. Power Switch

NOTE The power must be turned on before the chamber door can be opened.

Control Panel

The control panel is mounted at an angle on the front of the centrifuge and includes system keys, programming keys, and digital displays (see Figure 3.3). The panel also contains an **IMBALANCE** light that flashes if rotor loads are severely out of balance.

Figure 3.3 System Panels

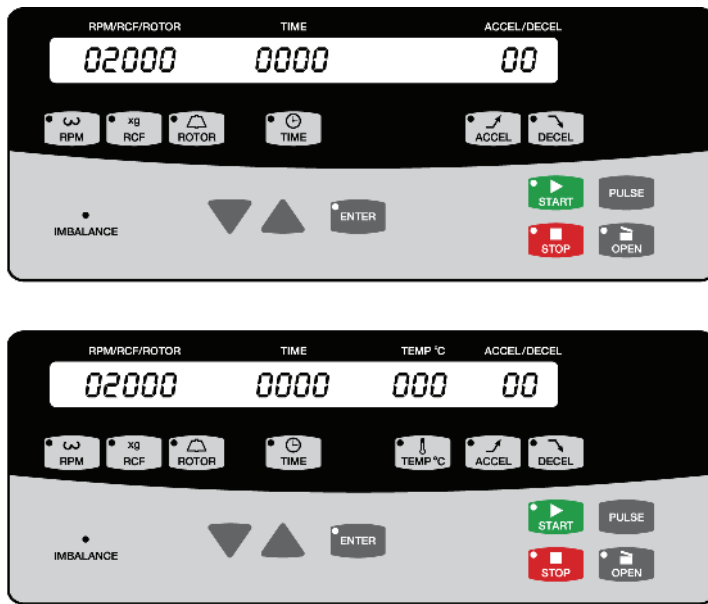

System Keys

The centrifuge operation is controlled through the system keys (see Figure 3.4). Each key (except the **PULSE** key) has an LED in the upper left corner that lights to indicate that the key can be activated.

Figure 3.4 System Keys



START	Pressing the START key causes the centrifuge run to begin. This key can also be used to abort a deceleration process and restart the centrifuge.
STOP	The STOP key can be pressed to end a run. It operates in two modes, depending on how you press it: <ul style="list-style-type: none"> • Normal stop (press and release): The centrifuge decelerates to a complete stop according to the preselected deceleration curve. Deceleration can be terminated and the centrifuge restarted by pressing START again. The centrifuge emits a series of audible tones when the rotor reaches 0 rpm. (Instructions for disabling the tones are in CHAPTER 5, Operation.) • Fast stop (press and hold for at least two seconds): The centrifuge decelerates to a complete stop at the maximum rate. The deceleration cannot be interrupted; the centrifuge can only be restarted after the rotor stops and the door is opened and closed.
OPEN DOOR	Pressing the OPEN DOOR key unlatches the centrifuge door locks and allows the door to be opened. The centrifuge accepts this command only when the rotor is completely stopped and the OPEN DOOR key LED is lit.
PULSE	Pressing the PULSE key causes the installed rotor to accelerate at the maximum rate up to the set speed for short-duration runs (as long as the key is pressed). Deceleration, at the maximum rate, begins when the key is released.

Program Keys

The program keys (see [Figure 3.5](#)) are used to set run parameters (a program consists of all of the parameters for a run). Except for the cursor and **ENTER** keys, program keys are located beneath the applicable digital displays, which show the parameters as they are input. Each key (except for the cursor keys) has an LED in the upper left corner that lights to indicate operational readiness. The LEDs also blink if an incorrect parameter is entered.

Figure 3.5 Program Keys

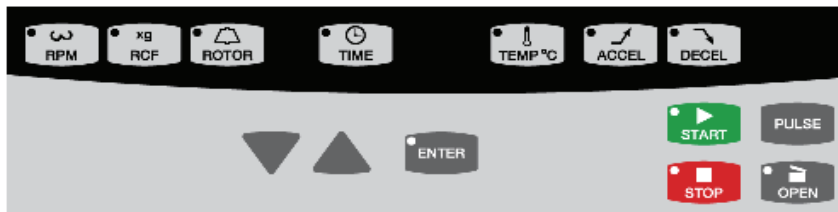

▲ ▼ (cursor keys)	The cursor keys are up and down arrow keys (▲ and ▼), which can be pressed to increment values up or down when setting parameters.
ENTER	Parameter (speed, time, temperature, and acceleration or deceleration curve) changes made while a run is in progress must be verified by pressing the ENTER key.
RPM	When the RPM key is pressed the last digit in the SPEED display (0) flashes, indicating that the speed can be entered in increments of 100 revolutions per minute (rpm). After the run starts, the actual rpm of the rotor is displayed.

RCF	The RCF key can be used to select the speed setting by required relative centrifugal field (RCF). The corresponding rpm is automatically calculated and displayed during the run. If the RCF key is pressed during the run, the RCF value is shown in the SPEED display.
ROTOR	The centrifuge memory contains a list of the rotors that can be used, together with default parameters for each rotor. When the ROTOR key is pressed, the number of the rotor used in the previous run is shown on the SPEED display. The rotor list can be scrolled through, using the cursor keys, until the required rotor number appears.
TIME	The TIME key is used to select the run duration. When the TIME key is pressed, the last digit on the TIME display flashes, indicating that the time can be entered with the cursor keys. <ul style="list-style-type: none"> • Timed run — Run time up to 9 hours and 59 minutes can be set. If the minutes parameter exceeds 59, it is automatically converted into hours. • Continuous run — If a run time of less than 1 minute or more than 9 hours and 59 minutes is selected, continuous operation is activated. Time is not counted down, and the run continues until the STOP key is pressed.
TEMP (refrigerated models only)	The TEMP key is used to select run temperature on refrigerated model centrifuges. When the TEMP key is pressed, the TEMP°C display flashes, indicating that the temperature can be entered with the cursor keys. Temperature can be set between -20°C and +40°C. The operating temperature range is +2°C to +40°C, depending on the rotor used and the speed selected.
ACCEL	The ACCEL key is used to select acceleration rates that protect delicate gradients. When the ACCEL key is pressed, the ACC/DEC display flashes, indicating that one of ten preset rates can be entered with the cursor keys (9 is the fastest rate and 0 is the slowest rate). Acceleration rates are described in Table 5.1 in CHAPTER 5, Operation .
DECEL	The DECEL key is used to select deceleration rates that maintain optimum separation while protecting delicate gradients. When the DECEL key is pressed, the ACC/DEC display flashes, indicating that one of ten preset rates can be entered with the cursor keys (9 is the fastest rate and 0 is a no-brake coast to stop). Deceleration rate selections are described in Table 5.1 in CHAPTER 5, Operation .

Digital Displays

Digital displays indicate rotor speed, run time, rotor chamber temperature, and numbers that represent selected acceleration and deceleration profiles (see [Figure 3.6](#)). When the power is turned on, they show the operating parameters of the most recent run performed before the power was turned off. The displays serve a dual purpose.

- When the run parameters are being set (the input mode), the displays show the set values (those selected by the operator). When a run-parameter key (for example, **TIME** or **RPM**) is pressed, the appropriate display flashes to indicate that data can be entered.
- The *actual* (real-time) operating conditions of the centrifuge are displayed during the run, after **START** is pressed.

NOTE Error messages (see Section 4) also appear on the displays, when applicable. The centrifuge emits a series of audible tones to alert the user to an error condition.

Figure 3.6 Digital Displays



<p>RPM/RCF/ROTOR</p>	<ul style="list-style-type: none"> • <i>In input mode</i>, the RPM/RCF/ROTOR display shows the value of the parameter being set, depending on the programming key pressed (RPM, RCF, or ROTOR). For example, if the ROTOR programming key is pressed, a rotor number appears on the SPEED display. • <i>During centrifugation</i>, the SPEED display shows the speed of the rotor in rpm. If the RCF key is pressed while the centrifuge is running, the RCF value is displayed.
<p>TIME</p>	<ul style="list-style-type: none"> • During a <i>timed run</i> (between 1 minute and 9 hours, 59 minutes), the TIME display begins counting down when the rotor starts to spin and continues the countdown until deceleration begins. The TIME display indicates the remaining run time in hours and minutes. • During a <i>continuous run</i> (less than 1 minute or more than 9 hours, 59 minutes selected), countdown time is not displayed. Instead, the infinity (∞) symbol, indicating continuous operation, lights up and the TIME display shows time elapsed since the run start. After 9 hours and 59 minutes, the timer resets to 0 and continues counting elapsed time.
<p>TEMP °C (refrigerated models only)</p>	<p>During standby (that is, the centrifuge is turned on but not spinning) and operation, the TEMP °C display shows the actual temperature inside the rotor chamber ($\pm 2^\circ\text{C}$ at an ambient temperature of 20°C).</p>
<p>ACCEL/DECEL</p>	<p>The ACCEL/DECEL display shows the acceleration curve that was selected for the run. The deceleration curve number can be displayed by pressing the DECEL key.</p>

Installation

Introduction

This chapter contains instructions for installing and connecting the centrifuge. Check that required clearances and electrical power are available.

 **WARNING**

These centrifuges each weigh 48 kg/106 lb (nonrefrigerated model) or 78 kg/172 lb (refrigerated model.) **DO NOT** attempt to lift or move one of them without assistance from a lifting device or another person.

Installing the Instrument

 **WARNING**

Do not place the centrifuge near areas containing flammable reagents or combustible fluids. Vapors from these materials could enter the centrifuge air system and be ignited by the motor.

 **WARNING**

Maintain a 7.6-cm (3-in.) clearance envelope around the centrifuge while it is running. No persons should be within this clearance boundary while the centrifuge is operating. Do not handle or store hazardous materials within the 30-cm (1-ft) area surrounding the centrifuge.

- 1 The centrifuge ships in a cardboard box on a wooden pallet. For easy access, remove the top of the box, the foam insert on top of the centrifuge, and then the upper part (sides) of the box and set them aside.
 - a. *With the help of another person*, move the centrifuge from the pallet to its final position.
 - (Note the warning above regarding centrifuge weight.)

- 2 Position the centrifuge on a level surface, such as a sturdy table or laboratory bench that is able to support the weight of the centrifuge and resist vibration.
 - Refer to *Nonrefrigerated Model Specifications* or *Refrigerated Model Specifications* in *CHAPTER 2, Introduction* for weight.
 - a. Make sure that the centrifuge front feet are fully supported on the table.
 - b. Locate the centrifuge in an area with sufficient ventilation to allow for heat dissipation.
 - c. Check that there are 7.6-cm (3-in.) clearances at the sides of the centrifuge to ensure sufficient air circulation.

Dimensions are shown in [Figure 4.1](#). Additional clearance is required on the right side to allow access to the power switch.

The centrifuge must have adequate air ventilation to ensure compliance to local requirements for vapors produced during operation.

Ambient temperatures during operation should not be lower than 10°C (50°F) or higher than 35°C (95°F) for refrigerated models, or lower than 4°C (39.2°F) or higher than 35°C (95°F) for nonrefrigerated models. Relative humidity should not exceed 80% (noncondensing).

NOTE During transport between areas with varying temperatures, condensation may occur inside the centrifuge. Allow sufficient drying time before running the centrifuge.

Transportation Safety Devices

A sheet of foam rubber is installed in the rotor chamber at the factory. A hole in the center of the foam stabilizes the drive shaft during transport. On receipt of the centrifuge, remove the foam and store it in case future relocation of the centrifuge is necessary.

Electrical Requirements

See the *Nonrefrigerated Model Specifications* or *Refrigerated Model Specifications* in *CHAPTER 2, Introduction* for centrifuge electrical requirements.

Make sure the voltage and frequency imprinted on the name rating plate affixed to the back of the centrifuge agree with the line voltage and frequency of the outlet used. Refrigeration does not function properly if the frequency [Hz] does not match the name rating plate. Plug in both ends of the centrifuge power cord. If there is any question about voltage, have a qualified service person measure it under load while the drive is operating.

A 1.8-m (6-ft) power cord with grounded plug is supplied with the centrifuge. Make sure that the matching wall outlet is located near the centrifuge and is easily accessible.

NOTE The power plug serves as the Disconnecting Device and must remain easily accessible.

Figure 4.1 Dimensions of the Refrigerated and Nonrefrigerated Centrifuges

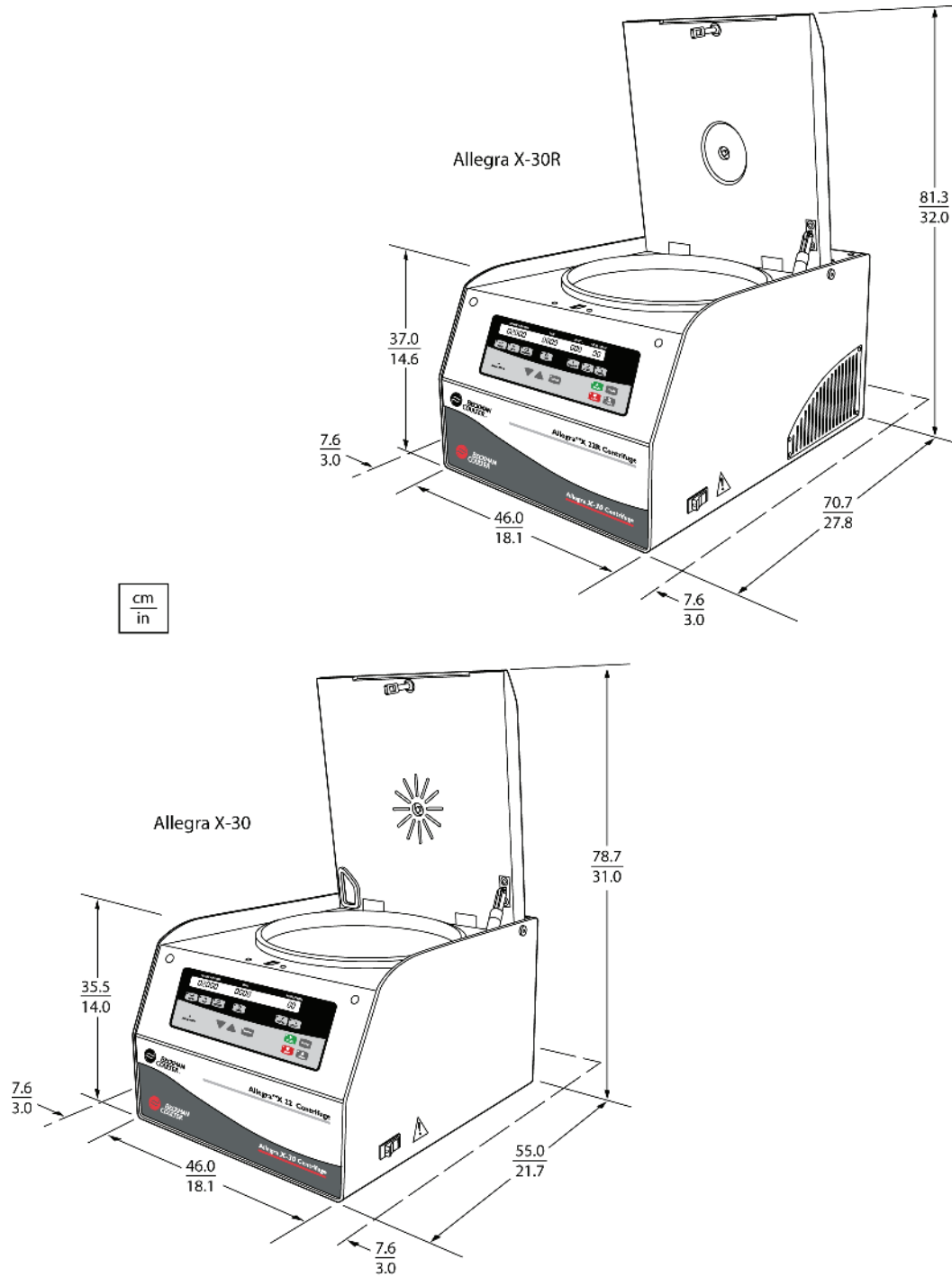

NOTE Additional clearance is required on the right side to allow to allow access to the power switch.

 **WARNING**

To reduce the risk of electrical shock, this equipment uses a three-wire electrical cord and plug to connect the centrifuge to earth-ground. To preserve this safety feature:

- Make sure that the matching wall outlet receptacle is properly wired and earth-grounded. Check that the line voltage agrees with the voltage listed on the name rating plate affixed to the centrifuge.
- Never use a three-to-two wire plug adapter.
- Never use a two-wire extension cord or a two-wire non-grounding type of multiple-outlet receptacle strip.

Test Run

NOTE The centrifuge must be plugged in and the power switch turned to on position (I) before the door can be opened.

We recommend that you make a test run to ensure that the centrifuge is in proper operating condition following shipment. See [CHAPTER 5, Operation](#) for instructions on operating the centrifuge.

After completing the test run, log on to www.beckmancoulter.com to register your centrifuge. This validates the centrifuge warranty and ensures your receipt of further information regarding new accessories and/or modifications as they become available.

Introduction

This section contains operating procedures for the centrifuge, using any of the Beckman Coulter rotors designed for use in these centrifuges. Refer to the applicable rotor manual for instructions on preparing the rotor for centrifugation. To prevent condensation, keep the centrifuge door closed and the power turned off (O) when the centrifuge is not in use.

NOTE If the centrifuge is used in a manner other than that specified in this manual, the safety and performance of this equipment could be impaired.

 **WARNING**

Normal operation may involve the use of solutions and test samples that are pathogenic, toxic, or radioactive. Operator error or tube failure may generate aerosols. Do not run potentially hazardous materials in this centrifuge unless all appropriate safety precautions are taken. Always use the appropriate rotors and adapters.

Handle all infectious samples according to good laboratory practices and methods to prevent the spread of disease. Ask your laboratory safety officer to advise you about the level of containment required for your application and about the proper decontamination or sterilization procedures to follow if fluids escape from containers. Biosafe containment should be used when Risk Group II materials (as identified in the World Health Organization *Laboratory Biosafety Manual*) are handled; materials of a higher group require more than one level of protection. Because spills may generate aerosols, observe proper safety precautions for aerosol containment.

 **WARNING**

The centrifuge must not be used in the vicinity of flammable liquids or vapors, and such materials should not be run in the centrifuge. During operation you should come within the 7.6 cm (3-in.) clearance envelope only to adjust instrument controls, if necessary. Never bring any flammable substances within the 30-cm (1-ft) area surrounding the centrifuge. Do not lean on the centrifuge or place items on the centrifuge while it is operating.

Run Procedure

The following detailed operating procedures are summarized at the end of this section. If you are an experienced user of this centrifuge, you can turn to the summary for a quick review of operating steps.

Preparation and Loading

For fast temperature equilibration, cool or warm the rotor to the required temperature before the run.

NOTE For high-speed runs at temperatures of 20°C or higher, prime the refrigeration system (refrigerated models) by running the instrument at 10°C for 5 to 10 minutes beforehand to prevent overheating.

NOTE Before installing the rotor, lubricate it following the instructions in the rotor manual.

- 1 Check the name rating plate for the correct voltage, then plug the power cord into the wall receptacle.
- 2 Press the power switch to on (I).
- 3 Press the **OPEN DOOR** key and lift the door up; it remains in the open position.
- 4 Use the T-handle wrench to turn the rotor tie-down screw to the left (counterclockwise).
 - a. Remove the tie-down screw.
- 5 Make sure that the tapered sleeve is in place at the base of the centrifuge drive shaft before installing the rotor (see [Figure 5.2](#)) and wipe the sleeve to be sure that it is clean and dry.
 - The rotor rests on the sleeve while spinning, and does not operate properly if the sleeve is missing.

Figure 5.1 Tapered Sleeve Position

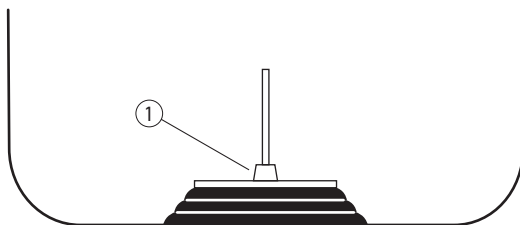

1. Tapered Sleeve

NOTE If the tapered sleeve comes off, it must be replaced by a Beckman Coulter Field Service representative. Call Beckman Coulter Field Service (1-800-742-2345 in the United States).

⚠ CAUTION

Do not drop the rotor onto the drive shaft. The shaft can be damaged if the rotor is forced sideways or dropped onto it. Install the rotor by centering it over the shaft and carefully lowering it straight down.

6 Install the rotor according to the instructions in the applicable rotor manual.

For a swinging bucket rotor, the steps include the following:

a. Lower the yoke straight down onto the drive shaft.

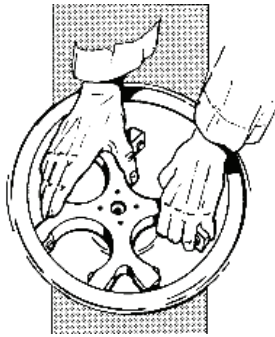

b. Tighten the tie-down screw clockwise onto the drive shaft.

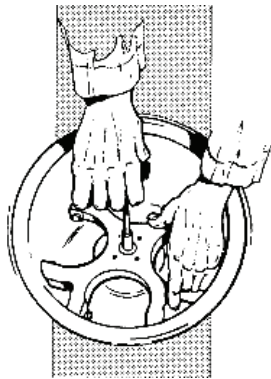

- c. Seat the filled buckets onto the yoke pins.
 - Be sure to fill all positions on the yoke with buckets.

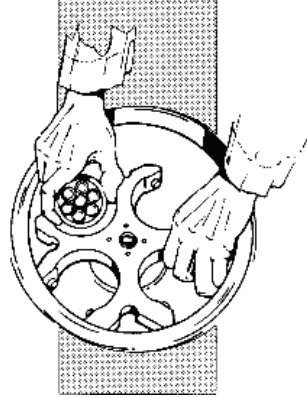

For a fixed angle rotor, the steps include the following:

- a. Lower the rotor straight down onto the drive shaft.

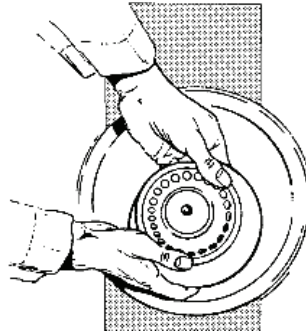

- b. Tighten the tie-down screw clockwise onto the drive shaft.

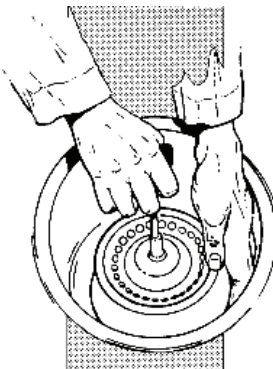

- c. Attach the lid and tighten it. Some rotors have a knob and others have a bolt for the T-handle wrench.



NOTE Fixed-angle rotors can be centrifuged without lids attached when longer tubes are used.

CAUTION

Always run any type of rotor with a balanced load.

- 7 Close the centrifuge door and push firmly down on both sides of the door front until you hear a clicking (latching) sound.
- 8 Remove the rotor from the centrifuge if a long period between runs is anticipated.

CAUTION

If the rotor is left in the centrifuge between runs, make sure the rotor is seated on the drive shaft and the tie-down screw is tight before each run.

Entering Run Parameters

When the power is applied for the initial use (no previous runs), default values are displayed (see [Figure 5.2](#)). After the initial use, the parameters of the latest previous run are displayed when power is applied.

When run parameters for a rotor have been entered, as described below, they are retained in the centrifuge memory and can be recalled by simply entering the rotor number. The recalled program can then be used for the current run or altered as required.

Figure 5.2 Default Parameters

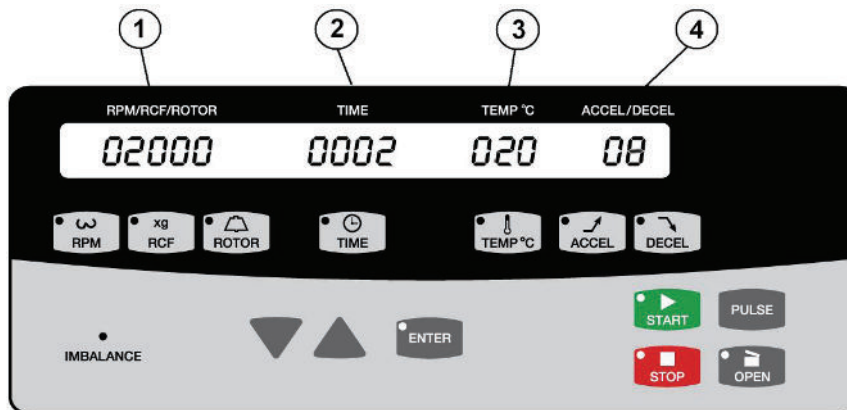

1. Accelerate rotor to 2000 RPM.
2. Continue run for two minutes.
3. Cool chamber to 20°C (refrigerated models only).
4. Use acceleration curve 8.

Selecting a Rotor Number

Each rotor that can be run in the centrifuge has a rotor number; the number is engraved on the rotor (and on the lid of fixed angle rotors). The centrifuge internal memory contains a list of all rotors that can be run in the centrifuge, together with acceptable run parameters for each rotor. If you enter an unauthorized rotor number then press the **START** key, an error message is displayed and the run is aborted shortly after the rotor starts spinning.

- 1 Press the **ROTOR** key.
A rotor number (the last rotor previously centrifuged) appears on the **SPEED** display.
- 2 Press the ▲ or ▼ cursor key until the number of the rotor in use appears.
- 3 Press **ENTER**.
 - Nominal parameter values (time, temperature, speed, acceleration and deceleration curves) for the selected rotor are shown.
 - You can use these parameters or set new values for the run.

Setting Run Speed

Centrifuge speed can be set for up to the maximum rated speed of the selected rotor. Either revolutions per minute (rpm) or relative centrifugal field (RCF) can be used to select speed. During centrifugation, the **SPEED** display indicates the actual run speed (RPM) of the rotor.

Setting RPM

- 1 Press the **RPM** key.
 - The last digit on the **SPEED** display (**0**) flashes, indicating that the RPM can be entered (in 100-RPM increments) with the cursor keys.
 - 2 Press the **▲** or **▼** cursor key until the required RPM is displayed.
 - The corresponding RCF is automatically calculated by the centrifuge, but the RPM value is displayed during the run.
 - You can check the RCF during the run by pressing the **RCF** key while the centrifuge is running.
-

Setting RCF

- 1 Press the **RCF** key.
 - The last digit on the **SPEED** display (**0**) flashes, indicating that you can enter the RCF.
 - 2 Press the **▲** or **▼** cursor key until the required RCF is displayed.
 - The corresponding RPM is automatically calculated and the centrifuge runs at the calculated speed.
-

Setting Run Time

Run time can be set for either a timed run or continuous operation.

Timed Run

Time can be set for up to 9 hours and 59 minutes (if the minutes parameter entered exceeds 59, it is automatically converted into hours). During centrifugation, the **TIME** display begins counting down when the rotor starts to spin and continues the count-down until deceleration begins. The **TIME** display shows the time remaining in the run, in hours and minutes. When the time display reaches zero, the run ends.

Continuous Run

If a run time of less than 1 minute or more than 9 hours and 59 minutes is selected, continuous operation is activated. Time is not counted down during continuous operation; instead, the infinity (∞) symbol, indicating continuous operation, lights up and time elapsed since the run start is displayed. The run continues until the **STOP** key is pressed.

- 1 Press the **TIME** key.

The last digit on the **TIME** display flashes, indicating that the time can be entered with the cursor keys.

-
- 2 Press the ▲ or ▼ cursor key until the required run duration is displayed.
-

Setting Run Temperature (refrigerated models only)

Run temperature can be set between -20°C and $+40^{\circ}\text{C}$. The typical operating range is from $+2^{\circ}\text{C}$ to 40°C , depending on the rotor and speed selected.

NOTE Temperatures may vary slightly between instruments. If sample temperature is crucial, test temperature settings on your instrument using water samples.

-
- 1 Press the **TEMP** key.
The **TEMP** $^{\circ}\text{C}$ display flashes, indicating that the temperature can be entered with the cursor keys.
-

- 2 Press the ▲ or ▼ cursor key until the required run temperature is displayed.
-

NOTE For runs at other than room temperature, refrigerate or warm the rotor beforehand for fast equilibration. For low-temperature runs, precool the centrifuge by running a 30-minute cycle at the required temperature (with a precooled rotor installed) with the speed set at about 2000 rpm.

Setting Acceleration Rate

The **ACCEL** key is used to select acceleration rates that protect delicate gradients. When the **ACCEL** key is pressed, the **ACC/DEC** display flashes, indicating that one of the 10 preset acceleration rates can be entered with the cursor keys. The selected rate depends on the type of run you are performing. For pelleting runs, where sample mixing is not a concern, maximum acceleration (setting 9) can be used. However, if delicate gradients are being run, a lower setting may be needed. Acceleration rates are listed in [Table 5.1](#).

-
- 1 Press the **ACCEL** key.
 - The **ACC/DEC** display flashes, indicating that the selected rate number can be entered with the cursor keys.
-

- 2 Press the ▲ or ▼ cursor key until the required number is displayed.
-

Table 5.1 Acceleration/Deceleration Times (in minutes:seconds^a)

Curve	Refrigerated Models				Nonrefrigerated Models			
	Swinging Bucket Rotors (4 700 rpm) ^b		Fixed Angle Rotors (18,000 rpm)		Swinging Bucket Rotors (4 200 rpm) ^b		Fixed Angle Rotors (16,000 rpm)	
	Accel	Decel	Accel	Decel	Accel	Decel	Accel	Decel
9	0:30	0:24	0:53	0:46	0:38	0:24	0:44	0:43
8	0:36	0:35	1:36	1:33	0:37	0:32	1:24	1:24
7	0:53	0:55	3:03	3:03	0:45	0:52	2:45	2:43
6	1:38	1:38	6:04	6:02	1:23	1:28	5:24	5:21
5	2:22	2:12	9:07	9:07	2:08	2:11	8:05	8:07
4	3:06	3:10	12:00	12:01	2:47	2:50	10:39	10:40
3	4:52	4:55	18:44	18:45	4:22	4:24	16:38	16:40
2	9:51	9:46	37:29	37:29	8:43	8:44	33:17	33:19
1	13:10	13:02	50:03	49:58	11:37	11:38	44:24	44:25
0	19:37	coast ^c	74:56	coast ^c	17:27	coast ^c	66:37	coast ^c

- a. Times are approximate; actual times vary depending on the rotor in use, the rotor load, run speed, and voltage fluctuations.
- b. Maximum speed for the S2096 microtiter rotor is 3000 rpm; acceleration and deceleration times decrease accordingly.
- c. Deceleration setting 0 is a no-brake coast to stop and, in some cases, may take less time than deceleration setting 1.

Setting Deceleration Rate

The **DECEL** key is used to select deceleration rates that maintain optimum separation. When the **DECEL** key is pressed, the **ACC/DEC** display flashes, indicating that one of the ten preset deceleration rates can be entered with the cursor keys. The selected rate depends on the type of run you are performing. For pelleting runs, where sample mixing is not a concern, maximum brake (setting 9) can be used. However, if delicate gradients are being run, a lower brake setting may be needed. Deceleration rates are listed in [Table 5.1](#).

1 Press the **DECEL** key.

The **ACC/DEC** display flashes, indicating that the selected number can be entered with the cursor keys.

2 Press the **▲** or **▼** cursor key until the required number is displayed.

Starting a Run

The run can be started using the parameters in memory from a previous run, or using new or changed parameters that you enter using the procedure described above.

-
- 1 Check that all parameters are correct and the door is shut and latched.
-
- 2 Press the **ENTER** key, then the **START** key.
 - As the run begins, the instrument rotor identification system compares the rotor in the chamber to the entered rotor number and the speed entered.
 - An incorrect rotor identification, or set speed greater than the *rotor's maximum permitted speed*, results in an error code and the centrifuge shuts down.
 - See [CHAPTER 6, Troubleshooting](#) for information on error codes.
 - The error must be cleared and an appropriate speed entered before the centrifuge can be started.
 - Throughout the run, checks are made to ensure that the rotor does not exceed set speed.
 - The **SPEED** display indicates the rotor speed in rpm.
 - (The RCF can be checked by pressing the **RCF** key.)
 - A blinking LED at the bottom of the **TIME** display indicates that the run is in progress.
 - This display also shows the time remaining in the run (or ∞ and elapsed time for continuous operation).



Do not attempt to override the door interlock system while the rotor is spinning.



Do not lift or move the centrifuge while the rotor is spinning. Do not place items on the centrifuge during operation.

Pulse Function

The pulse function, accessed by pressing the **PULSE** key, is used for short-duration runs as follows.

- When the **PULSE** key is pressed, the rotor accelerates at maximum rate to the set speed and continues to spin as long as the **PULSE** key is pressed. (The current run time, acceleration, and deceleration settings are overridden by the pulse function.) When the **PULSE** key is released, the rotor begins decelerating to 0 rpm using maximum deceleration. Using the pulse function eliminates the need to press the **START** and **STOP** keys.
- When the **PULSE** key is pressed, the **TIME** display begins displaying the elapsed seconds. When the **PULSE** key is released, the seconds stop accumulating. The **ACCEL/DECEL** display continues to show the user-entered settings during a pulse run even though the maximum rates are used.

- If the **PULSE** key is pressed while the rotor is running at set speed, the rotor continues running at speed until the **PULSE** key is released. When the **PULSE** key is released, the rotor begins decelerating to 0 rpm using maximum deceleration.
- The centrifuge memory retains the parameters of the last run performed before the **PULSE** key was pressed. At the end of a pulse run, after the centrifuge door is opened and closed, the previous run parameters are displayed.

Changing Parameters During a Run

While a run is in progress, run parameters (speed, time, temperature, and acceleration or deceleration rate) can be altered without stopping the run. Run duration can also be changed from continuous to a specified time period, or from a specified time period to continuous.

NOTE The deceleration rate cannot be changed after deceleration starts.

Use the program keys as described under *Entering Run Parameters*, above, to change parameters. Parameter changes made during a run must be verified by pressing the **ENTER** key. For example, to change run speed during centrifugation:

-
- 1** Press the **RPM** key.
 - The last digit on the **SPEED** display flashes, indicating that the rpm can be raised or lowered with the cursor keys.
 - 2** Press the ▲ or ▼ cursor key until the required rpm is displayed.
 - 3** Press the **ENTER** key.
 - The current RPM value is displayed, changing to the new value as the rotor accelerates or decelerates to the new speed selected.
 - The corresponding RCF is automatically calculated by the centrifuge.
-

Stopping a Run

A timed run ends automatically when the **TIME** display counts down to zero. The centrifuge emits a series of audible tones when the rotor reaches 0 rpm. (Instructions for disabling the audible tones are on page 5-12, *Disabling the Audible Tones*.) To end a run in progress for any reason:

-
- 1 Press the **STOP** key for normal deceleration as selected by the deceleration curve.
(or)

Press and hold the **STOP** key for deceleration at the maximum rate (see [Table 5.1](#)).

NOTE If you hold the **STOP** key for more than a full second, the deceleration process cannot be interrupted; the centrifuge cannot be restarted until the rotor comes to a complete stop and the door is opened and closed.

-
- 2 *After the rotor stops spinning* and the **OPEN DOOR** light comes on, press the **OPEN DOOR** key to release the door latches, then open the door.

NOTE To prevent chamber icing, use a sponge to wipe condensation out of the chamber bowl between runs.

Unloading

NOTE When you remove the rotor, make sure that the tapered sleeve from the centrifuge drive shaft does not come out with the rotor. If the tapered sleeve is inside the rotor drive hole, call Beckman Coulter Field Service (1-800-742-2345 in the United States).

After completing a run, unload the rotor following the instructions in the applicable rotor manual.



If disassembly reveals evidence of leakage, you should assume that some fluid escaped the rotor. Apply appropriate decontamination procedures to the centrifuge and accessories.

Disabling the Audible Tones

The audible tones (beeps) that sound at the end of each run and if an error occurs may be turned on and off by following the steps below (rotor must be at 0 rpm).

-
- 1 Press the **STOP** key and hold for 3 seconds until the word “**Beep**” appears in the display.
-
- 2 Press either the ▲ or ▼ cursor key to turn the beeps on or off.
 - (The word “**on**” or “**off**” is displayed to indicate the current setting.
 - The arrow keys toggle between on and off settings.)

-
- 3 Press **ENTER** to save the selection.
-

Summary of Run Procedures

For runs at other than room temperature, refrigerate or warm the rotor beforehand for fast equilibration. For low-temperature runs, precool the centrifuge by running a 30-minute cycle (with a precooled rotor installed) at the required temperature with the speed set at 2000 rpm.

- 1 Press the POWER switch to on (I).
 - a. Open the centrifuge door (press the **OPEN DOOR** key and lift the door up).
- 2 Make sure that the tapered sleeve is in place at the base of the centrifuge drive shaft before installing the rotor.
 - The rotor does not operate properly if the sleeve is missing.
- 3 Install the rotor according to the instructions in the applicable rotor manual.
 - a. *Always run the rotor with a balanced load.*
- 4 Close the centrifuge door and push firmly down on it until you hear the latch engage.
- 5 Enter run parameters:
 - a. Select a rotor number – **ROTOR**, ▲ or ▼, **ENTER**
 - b. Set run speed – **RPM**, ▲ or ▼; or **RCF**, ▲ or ▼
 - c. Set run duration – **TIME**, ▲ or ▼
 - d. Set run temperature – **TEMP**, ▲ or ▼
 - e. Select acceleration rate (0 through 9) – **ACCEL**, ▲ or ▼
 - f. Select deceleration rate (0 through 9) – **DECEL**, ▲ or ▼
- 6 Check that all parameters are correct and the door is shut and latched, then press **ENTER**, then **START**.

 **WARNING**

Never attempt to override the door interlock system while the rotor is spinning.



Do not lift or move the centrifuge while the rotor is spinning.

7 Wait for the set time to count down to zero, or end the run by pressing or holding the **STOP** key.

8 *After the rotor stops spinning* and the **OPEN DOOR** light comes on, press the **OPEN DOOR** key to release the door latch; open the door.

9 Unload the rotor according to instructions in the applicable rotor manual.



If disassembly reveals evidence of leakage, you should assume that some fluid escaped the rotor. Apply appropriate decontamination procedures applied to the centrifuge and accessories.

Troubleshooting

Introduction

This section lists possible malfunctions, together with probable causes and corrective actions required. Maintenance procedures are contained in [CHAPTER 7, Care and Maintenance](#). For any problems not covered here, contact Beckman Coulter Field Service.

NOTE It is your responsibility to decontaminate the centrifuge, as well as any rotors and accessories, before requesting service by Beckman Coulter Field Service.

User Messages

 **CAUTION**

If the message SEr appears on the display, do not press any keys while the message is displayed. Turn the centrifuge power off (O) and back on (I) to clear the message. This message indicates that you have inadvertently accessed the service mode. Pressing any keys while in this mode could erase the centrifuge memory and critically interfere with future operation.

If a problem occurs during operation, the rotor decelerates to a stop, an error code appears on the **SPEED** display, and the centrifuge emits a series of audible tones to alert the operator to the error condition. Such problems may result from incorrect input or from an equipment malfunction. Refer to [Table 6.1](#) to determine the nature of the problem and recommended actions. If you are unable to correct the problem, call Beckman Coulter Field Service. To help diagnose and correct the problem, gather as much information about the situation as you can:

- Write down the error number that appears on the display.
- Note the operating situation when the error occurred (rotor in use, speed, load type, etc.).
- Note any unusual environmental and/or operating conditions (ambient temperature, voltage fluctuations, etc.).
- Add any other information that may be helpful.

NOTE Instructions for disabling the audible tones are in [CHAPTER 5, Operation](#).

Table 6.1 Error Message Chart^a

Error Number	Problem	Result	Recommended Action
1 through 23, 25 and 26, 28 through 30 32, 36, 39 and 40, 44 through 60, 63 through 68	Microprocessor or mechanical malfunction	Deceleration to full stop; run cannot be restarted	After rotor comes to a complete stop, turn the power off (O), then back on (I) to reset.
23 and 24, 27, 31, 33 through 35, 37 and 38, 41 through 43, 62	Microprocessor or mechanical malfunction	Deceleration to full stop; run cannot be restarted	After rotor comes to a complete stop, open and close the centrifuge door, then restart.
69 through 77	Microprocessor malfunction	Run cannot start until error is cleared	Turn the power off (O), then back on (I) to reset.
78 through 80	Error during closing of door	Run cannot start	<ol style="list-style-type: none"> 1. Remove debris in latch 2. Close lid quickly. 3. Turn the power off (O), then back on (I) to reset.
81	" Door open " detected during run	Maximum deceleration to full stop	After rotor comes to a complete stop, shut the centrifuge door, turn the power off (O), then back on (I) to reset.
82, 83	Door does not open	—	See Emergency Access , below
84	Motor overtemperature	Deceleration to full stop	<ol style="list-style-type: none"> 1. Check that ambient temperature is within a the limits shown in the Specifications in CHAPTER 2, Introduction. 2. Check air inlets and exhausts for obstructions. <p>After the motor has cooled, restart. If the problem persists, call Beckman Coulter Field Service.^b</p>
85 through 87	Rotor chamber overtemperature (refrigerated models)	Deceleration to full stop	
90 through 96	Temperature sensor malfunction (refrigerated models)	Maximum deceleration to full stop	Turn the power off (O), then back on (I) to reset.
98	Rotor not recognized	Maximum deceleration to full stop	Check that the installed rotor is usable in the centrifuge. If incorrect, install an authorized rotor; if rotor is authorized and problem persists, call Beckman Coulter Field Service.
99	Rotor recognized but incorrect	Maximum deceleration to full stop	Input correct parameters for the rotor in use, then restart.

a. If the recommended action does not correct the problem, call Beckman Coulter Field Service.

b. In the United States, call 1-800-742-2345; outside the U.S., contact your local Beckman Coulter office.

Other Possible Problems

Possible malfunctions that may not be indicated by diagnostic messages are described in [Table 6.2](#), along with probable causes and corrective actions required. Possible causes for each problem are listed in the probable order of occurrence. Perform the recommended corrective action in sequence, as listed. If you are unable to correct the problem, call Beckman Coulter Field Service.

Table 6.2 Troubleshooting Chart

Problem	Problem/Result	Recommended Action
Imbalance LED lights and rotor decelerates to stop	<ol style="list-style-type: none"> 1. Rotor is out of balance 2. Centrifuge is misaligned (tilted) 3. Centrifuge was moved during operation 4. Drive error (mechanical damage) 	<ol style="list-style-type: none"> 1. Check to be sure the rotor is in good condition and is loaded symmetrically around the center of rotation, with containers of equal weight and density opposite each other. 2. Align the centrifuge on the bench or table. 3. After the rotor comes to a complete stop, open and close the centrifuge door, then restart. 4. Call Beckman Coulter Field Service.
Rotor cannot achieve set speed	<ol style="list-style-type: none"> 1. Line voltage below rating 2. Electrical failure 3. Motor failure 	<ol style="list-style-type: none"> 1. Have a qualified service person measure line voltage while the instrument is operating. 2. Make sure both ends of the power cord are securely connected; call Beckman Coulter Field Service. 3. Call Beckman Coulter Field Service.
Door does not open	<ol style="list-style-type: none"> 1. Rotor spinning 2. Power not on 3. Source power failure 4. Latch stuck 	<ol style="list-style-type: none"> 1. Wait until the rotor stops. 2. Plug in the power cord; turn power on (I). 3. See Emergency Access, below. 4. See Emergency Access below.
Displays are blank	<ol style="list-style-type: none"> 1. Power not on 2. Electrical failure 3. Fuse blown 	<ol style="list-style-type: none"> 1. Plug in the power cord; turn power on (I). 2. Make sure both ends of the power cord are securely connected; call Beckman Coulter Field Service. 3. System fuses cannot be replaced by the user. Call Beckman Coulter Field Service.
TEMP °C display flashes (refrigerated models)	Chamber temperature is >25°C higher than selected temperature	Precool rotors before running at low temperatures. Precool rotor chamber by running a 30-minute cycle at the desired temperature with the speed set at about 2000 rpm. If a lower temperature deviation alert is required, contact Beckman Coulter Field Service.
Chamber does not reach selected temperature (refrigerated models)	Centrifuge cannot maintain selected temperature for rotor in use at speed selected	Refer to applicable rotor manual for temperature and speed requirements. Also, precool rotors before running at low temperatures. Precool rotor chamber by running a 30-minute cycle at the desired temperature with the speed set at 2000 rpm.

Emergency Access

If the facility power fails only momentarily, the centrifuge resumes operation when power is restored and the rotor returns to set speed. However, if the rotor comes to a complete stop you have to restart the run when the power is restored. In the event of an extended power failure, you may have to trip the door-locking mechanism manually to remove the rotor and retrieve your sample.

WARNING

Any maintenance procedure requiring removal of a panel exposes the operator to the possibility of electrical shock and/or mechanical injury. Therefore, turn the power off and disconnect the instrument from the main power source by removing its power plug from the receptacle, and refer such maintenance to qualified service personnel.

- 1 Turn the power switch to off (O) and disconnect the power cord from the main power source by removing its power plug from the receptacle.

WARNING

Never attempt to override the door interlock system while the rotor is spinning.

- 2 Make sure that the rotor is not spinning.

CAUTION

Do not proceed if there is any sound or vibration coming from the drive.

- 3 Use a small flat-blade screwdriver to pry off the two round screw-hole covers on the centrifuge front panel (see Figure 6.1).

Figure 6.1 Screw Locations

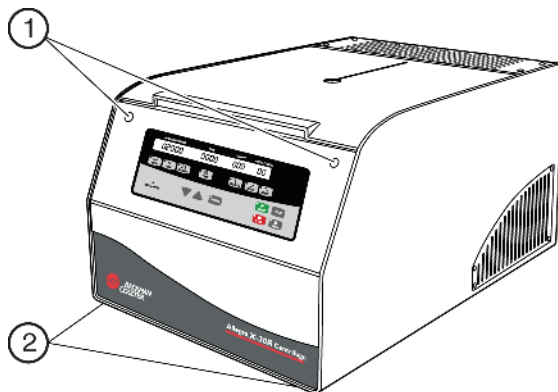

1. Upper screws and covers.
2. Lower screws, not visible from the front.

- 4 Set the covers aside.
- 5 Insert a Phillips-head screwdriver through one of the exposed holes in the centrifuge front panel and loosen, but do not remove, the screw.
 - a. Repeat for the other screw.
- 6 Move the centrifuge forward on the bench until the two screws on the bottom of the centrifuge are accessible (see [Figure 6.1](#)).
- 7 Use a Phillips-head screwdriver to remove the two screws and set them aside.
- 8 Carefully lift the centrifuge front cover until the bottom releases, then pull the top towards you slightly.
To support the cover, insert the cover bottom lip under the standoff plate inside the centrifuge.

CAUTION

Do not allow the cover to hang down supported only by the exposed power and grounding wires or the wires will be damaged.

- 9 Pull the latch-release cable firmly to the right until the latches release and the door opens (see [Figure 6.2](#)).

Figure 6.2 Internal Access

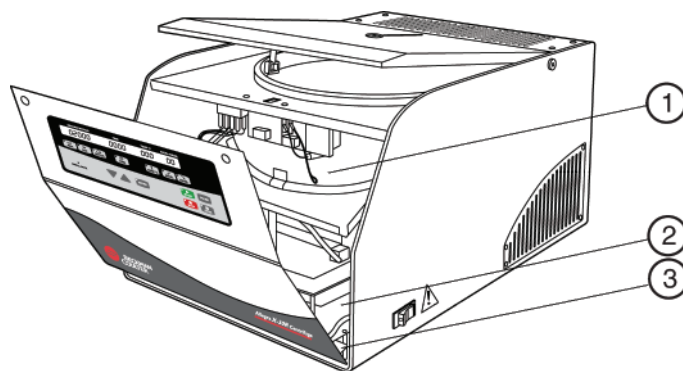

1. Latch release cable.
2. Standoff plate.
3. Cover bottom lip goes here.

10 If the rotor is still spinning, close the door and wait until it stops before attempting to remove it.



Never try to slow or stop the rotor by hand.

11 After removing the rotor, replace the front panel, screws, and covers.

Care and Maintenance

Introduction

For maintenance not covered in this manual, contact Beckman Coulter Field Service. User messages are discussed in [CHAPTER 6, Troubleshooting](#). Refer to the applicable rotor manual and to Chemical Resistances (publication IN-175) for instructions on the care of rotors and their accessories.

NOTE It is your responsibility to decontaminate the centrifuge, as well as any rotors and accessories, before requesting service by Beckman Coulter Field Service.

 **WARNING**

Any maintenance procedure or servicing of this equipment that requires removal of any covers can expose parts which involve the risk of electric shock or personal injury. Make sure that the power switch is off (O) and the centrifuge is disconnected from the main power source by removing its power plug from the receptacle, and refer such servicing to qualified service personnel.

Do not use alcohol or other flammable substances in or near operating centrifuges.

Maintenance

Preventive Maintenance

The following procedures should be performed regularly to ensure continued performance and long service life of the centrifuge.

- 1 Regularly inspect the interior of the rotor chamber for accumulations of sample, dust, or glass particles from broken sample tubes.
 - a. Clean as required (see [Cleaning](#), below), as these accumulations can result in rotor vibrations.

-
- 2 Regularly check the air intake and exhaust vents for obstructions.
 - a. Keep vents clear and clean.

 - 3 Use a sponge to wipe condensation out of the chamber bowl between runs to prevent chamber icing (refrigerated models).
 - a. If chamber icing occurs, defrost before use.

 - 4 To prevent the rotor from sticking, lubricate the drive shaft with Spinkote at least once a month, and after each cleaning.
-

Replacing the Rotor Chamber Gasket

If the gasket around the rotor chamber opening becomes damaged or worn, replace it as follows. (See [Figure 7.1](#).)

-
- 1 Remove the gasket by pulling it up and away from the opening.

 - 2 Install the new gasket by positioning the groove in the gasket over the rim of the opening.

 - 3 Press the gasket around the opening so that the rim is seated in the gasket groove.
-

Figure 7.1 Replacing the Rotor Chamber Gasket

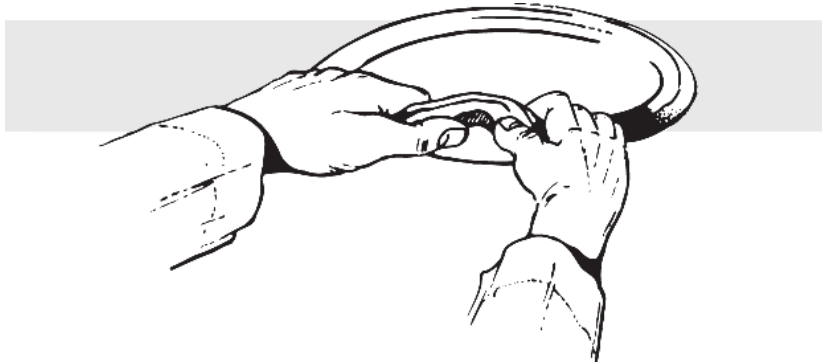

Cleaning

Frequent cleaning is recommended to prolong the life of the centrifuge. *Always clean up spills when they occur to prevent corrosives or contaminants from drying on component surfaces.*

NOTE Before using any cleaning or decontamination methods except those recommended by the manufacturer, users should check with the manufacturer that the proposed methods will not damage the equipment.

- 1** To prevent accumulations of sample, dust, and/or glass particles from broken sample tubes, keep the interior of the rotor chamber clean and dry by frequent wiping with a cloth or paper towel.
- 2** Clean the drive shaft, shaft cavity, threads, and the tie-down screw at least once a week using a mild detergent such as Beckman Solution 555™ and a soft brush.
 - a.** Dilute the detergent 10 to 1 with water.
 - b.** Rinse thoroughly and dry completely.
 - c.** Lubricate the drive shaft with Spinkote after cleaning.
- 3** Wash the bowl using a mild detergent such as diluted Solution 555.
 - a.** Rinse thoroughly and dry completely.
 - b.** If a cleaning solution other than Solution 555 is used, consult *Chemical Resistances* (publication IN-175) or contact the cleaning-solution vendor to verify that the solution will not damage the centrifuge.
- 4** Clean the centrifuge case and door by wiping with a cloth dampened with diluted Solution 555. Do not use acetone or other solvents.

Tube Breakage

If a glass tube breaks, and all the glass is not contained in the bucket or rotor, you must thoroughly clean the interior of the chamber bowl.

 **WARNING**

Be careful when examining or cleaning the sealing gasket or chamber, as sharp glass fragments may be embedded in their surfaces.

-
- 1 Examine the gasket to make sure that no glass particles are retained in it.
 - a. Carefully remove any glass particles that may remain.
-
- 2 Carefully wipe away any glass particles that remain in the bowl.
-

Decontamination

If the centrifuge and/or accessories are contaminated with radioactive or pathogenic solutions, perform appropriate decontamination procedures. Refer to *Chemical Resistances* (IN-175) to be sure the decontamination method will not damage any part of the centrifuge.

Sterilization and Disinfection

The centrifuge is finished with urethane paint. Ethanol (70%)* may be used on this surface. See *Chemical Resistances* for more information regarding chemical resistance of centrifuge and accessory materials.

While Beckman Coulter has tested these methods and found that they do not damage the centrifuge, no guarantee of sterility or disinfection is expressed or implied. When sterilization or disinfection is a concern, consult your laboratory safety officer regarding proper methods to use.

Storage and Transport

Storage

Before storing a centrifuge for an extended period, return it to its original shipping container to protect it from dust and dirt. Reinsert the shipping foam (removed at time of centrifuge installation) into the chamber, making sure the drive shaft is stabilized in the hole in the foam. Temperature and humidity conditions for storage should meet the environmental requirements described in the specifications given in [CHAPTER 2, Introduction](#).

Returning a Centrifuge

Before returning a centrifuge or accessory for any reason, prior permission (a Returned Material Authorization form for united States returns or Returned Goods Authorization form for international returns) must be obtained from Beckman Coulter, Inc. Contact your local Beckman Coulter office to obtain the RGA form and for packaging and shipping instructions.

* Flammability hazard. Do not use in or near operating centrifuges.

To protect our personnel, it is the customer's responsibility to ensure that all parts are free from pathogens and/or radioactivity. Sterilization and decontamination must be done before returning the parts.

All parts must be accompanied by a signed note, plainly visible on the outside of the box, stating that they are safe to handle and that they are not contaminated with pathogens or radioactivity. Failure to attach this notification will result in return or disposal of the items without review of the reported problem.

Supply List

Contact Beckman Coulter Sales (worldwide offices are listed at the back of this manual or visit www.beckman.com) for information about ordering parts, supplies, and publications. For your convenience, a partial list is given below.

Refer to the applicable rotor manual for materials and supplies needed for rotors.

Replacement Parts

Rotor chamber gasket (X-30R)	392201
Rotor tie-down screw	361367
T-handle wrench	361371

Other

Spinkote lubricant (2 oz)	306812
Silicone vacuum grease (1 oz)	335148
Beckman Solution 555 (1 qt)	339555

Beckman Coulter, Inc.

Allegra X-30 Series Centrifuge Warranty

Subject to the exceptions and upon the conditions specified below, Beckman Coulter agrees to correct, either by repair, or, at its election, by replacement, any defects of material or workmanship which develop within one (1) year after delivery of the Allegra X-30 series centrifuge (the product), to the original Buyer by Beckman Coulter or by an authorized representative provided that investigation and factory inspection by Beckman Coulter discloses that such defect developed under normal and proper use.

Some components and accessories by their nature are not intended to and will not function for as long as one (1) year. A complete list of such components or accessories is maintained at the factory and at each Beckman Coulter District Sales Office. The lists applicable to the products sold hereunder shall be deemed to be part of this warranty. If any such component or accessory fails to give reasonable service for a reasonable period of time, Beckman Coulter will repair or, at its election, replace such component or accessory. What constitutes either reasonable service and a reasonable period of time shall be determined solely by Beckman Coulter.

Replacement

Any product claimed to be defective must, if requested by Beckman Coulter, be returned to the factory, transportation charges prepaid, and will be returned to Buyer with the transportation charges collect unless the product is found to be defective, in which case Beckman Coulter will pay all transportation charges.

Conditions

Beckman Coulter shall be released from all obligations under all warranties either expressed or implied, if the product(s) covered hereby are repaired or modified by persons other than its own authorized service personnel, unless such repair in the sole opinion of Beckman Coulter is minor, or unless such modification is merely the installation of a new Beckman Coulter plug-in component for such product(s).

Disclaimer

IT IS EXPRESSLY AGREED THAT THE ABOVE WARRANTY SHALL BE IN LIEU OF ALL WARRANTIES OF FITNESS AND OF THE WARRANTY OF MERCHANTABILITY AND THAT NEITHER BECKMAN COULTER, INC. NOR ITS SUPPLIERS SHALL HAVE ANY LIABILITY FOR SPECIAL OR CONSEQUENTIAL DAMAGES OF ANY KIND WHATSOEVER ARISING OUT OF THE MANUFACTURE, USE, SALE, HANDLING, REPAIR, MAINTENANCE, OR REPLACEMENT OF THE PRODUCT.

Symbol Symbol Symbole Símbolo	Simbolo 記号 符号 Title / Titel / Titre / Titolo / Titolo / 名称 / 名称
	Dangerous voltage Gefährliche elektrische Spannung Courant haute tension Voltaje peligroso Pericolo: alta tensione 危険電圧 危险电压
	Attention, consult accompanying documents Achtung! Begleitpapiere beachten! Attention, consulter les documents joints Atención, consulte los documentos adjuntos Attenzione: consultare le informazioni allegate 注意、添付資料を参照のこと 注意，请参阅附带的文件
	On (power) Ein (Netzverbindung) Marche (mise sous tension) Encendido Acceso (sotto tensione) 入（電源） 开（电源）
	Off (power) Aus (Netzverbindung) Arrêt (mise hors tension) Apagado Spento (fuori tensione) 切（電源） 关（电源）
	Protective earth (ground) Schutzleiteranschluß Liaison à la terre Puesta a tierra de protección Collegamento di protezione a terra 保護アース（接地） 保护接地
	Earth (ground) Erde Terre Tierra Scarica a terra アース（接地） 接地

Related Documents

Additional References

- Chemical Resistances for Beckman Coulter Centrifugation Products (IN-175)

Available in hard copy or electronic pdf by request.

Available at www.beckmancoulter.com

www.beckmancoulter.com

