

# Instruction For Use

## Avanti J-26XP

High-Performance Centrifuge

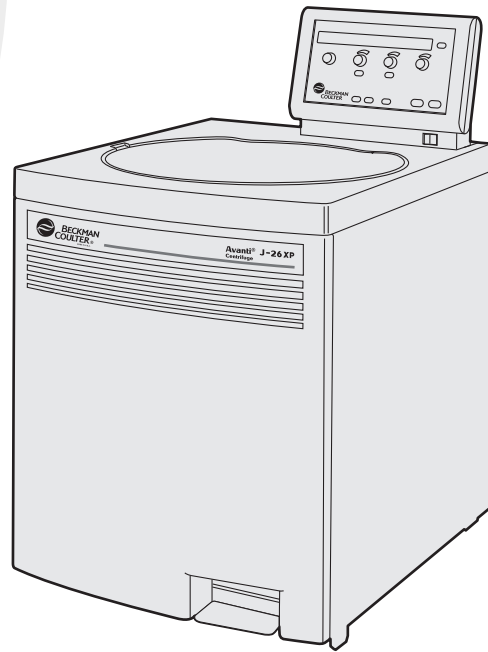

J326XP-IM-5AB  
January 2012



Beckman Coulter, Inc.  
250 S. Kraemer Blvd.  
Brea, CA 92821



**Avanti J-26XP**  
**High-Performance Centrifuge**  
J326XP-IM-5AB (January 2012)

Copyright © 2012 Beckman Coulter, Inc.

All rights reserved. No part of this document may be reproduced or transmitted in any form or by any means, electronic, mechanical, photocopying, recording, or otherwise, without prior written permission from Beckman Coulter, Inc.

Find us on the World Wide Web at:

[www.beckmancoulter.com](http://www.beckmancoulter.com)

# Safety Notice

Read all product manuals and consult with Beckman Coulter-trained personnel before attempting to operate the instrument. Do not attempt to perform any procedure before carefully reading all instructions. Always follow product labeling and manufacturer's recommendations. If in doubt as to how to proceed in any situation, contact your Beckman Coulter Representative.

## Alerts for Danger, Warning, Caution, and Note

---



**DANGER** indicates an imminently hazardous situation which, if not avoided, will result in death or serious injury.



**WARNING** indicates a potentially hazardous situation which, if not avoided, could result in death or serious injury.



**CAUTION** indicates a potentially hazardous situation, which, if not avoided, may result in minor or moderate injury. It may also be used to alert against unsafe practices.

**NOTE** NOTE is used to call attention to notable information that should be followed during installation, use, or servicing of this equipment.

## Safety During Installation and/or Maintenance

---

This instrument is designed to be installed by a Beckman Coulter Field Service representative. Installation by anyone other than authorized Beckman Coulter personnel invalidates any warranty covering the instrument. Also, if the instrument needs to be moved, a Beckman Coulter Field Service representative must reinstall and relevel the instrument in its new location.

Any servicing of this equipment that requires removal of any covers can expose parts which involve the risk of electric shock or personal injury. Make sure that the power switch is turned off and the instrument is disconnected from the main power source, and refer such servicing to qualified personnel.

Be sure to use the anchoring system to secure the centrifuge in place. The anchoring system is designed to reduce the possibility of injury or damage that could result from instrument movement in the event of a major rotor mishap.

Do not replace any centrifuge components with parts not specified for use on this instrument.

## Electrical Safety

---

To reduce the risk of electrical shock, this instrument uses a three or five-wire electrical cord and plug to connect this equipment to earth-ground. To preserve this safety feature:

- Make sure that the matching wall outlet receptacle is properly wired and earth-grounded. Check that the line voltage agrees with the voltage listed on the name-rating plate affixed to the centrifuge.
- Never use a three-to-two wire plug adapter.
- Never use a two-wire extension cord or a two-wire non-grounding type of multiple-outlet receptacle strip.

Do not place containers holding liquid on or near the chamber door. If they spill, liquid may get into the instrument and damage electrical or mechanical components.

## Safety Against Risk of Fire

---

This instrument is not designed for use with materials capable of developing flammable or explosive vapors. Do not centrifuge such materials (for example, chloroform or ethyl alcohol) in this instrument nor handle or store them near the centrifuge.

## Mechanical Safety

---

For safe operation of the equipment, observe the following:

- Use only the Beckman Coulter rotors and accessories designed for use in this instrument.
- Do not exceed the maximum rated speed of the rotor in use.
- NEVER attempt to slow or stop a rotor by hand.
- Do not lift or move the centrifuge while a rotor is spinning.
- NEVER attempt to override the door interlock system while the rotor is spinning.
- Do not lean on the centrifuge or place items on it while it is operating.

## Chemical and Biological Safety

---

Normal operation may involve the use of solutions and test samples that are pathogenic, toxic, or radioactive. Such materials should not be used in this instrument, however, unless *all necessary safety precautions are taken*.

- Handle body fluids with care because they can transmit disease. No known test offers complete assurance that they are free of micro-organisms. Some of the most virulent—Hepatitis (B and C) and HIV (I–V) viruses, atypical mycobacteria, and certain systemic fungi—further emphasize the need for aerosol protection. Handle other infectious samples according to good laboratory

procedures and methods to prevent spread of disease. Because spills may generate aerosols, observe proper safety precautions for aerosol containment. Do not run toxic, pathogenic, or radioactive materials in this centrifuge without taking appropriate safety precautions. Biosafe containment should be used when Risk Group II materials (as identified in the World Health Organization *Laboratory Biosafety Manual*) are handled; materials of a higher group require more than one level of protection.

- Dispose of all waste solutions according to appropriate environmental health and safety guidelines.

**It is your responsibility to decontaminate the instrument and accessories before requesting service by Beckman Coulter Field Service.**



## Safety Notice, iii

Alerts for Danger, Warning, Caution, and Note, iii

Safety During Installation and/or Maintenance, iii

Electrical Safety, iv

Safety Against Risk of Fire, iv

Mechanical Safety, iv

Chemical and Biological Safety, iv

## Introduction, xiii

Certification, xiii

Scope of This Manual, xiii

Conventions, xiv

CFC-Free Centrifugation, xiv

Radio Interference, xiv

Recycling Label, xv

## **CHAPTER 1:**

Specifications, 1-1

Control Features, 1-1

Operational Features, 1-2

Physical Data, 1-2

Available Rotors, 1-3

Preinstallation Requirements, 1-7

Electrical Requirements, 1-8

Space and Location Requirements, 1-11

Securing the Centrifuge to the Floor, 1-11

Using J2 Series Rotors in the Avanti J, 1-13

Checking for Rotor Drive Pins, 1-13

Using the JA-18 Rotor, 1-14

Using the JCF-Z Continuous Flow/Zonal Rotor, 1-14

<b>CHAPTER 2:</b>	Centrifuge Function and Safety Features, 2-1 <ul style="list-style-type: none"><li>Centrifuge Function, 2-1</li><li>Safety Features, 2-2</li><li>Housing and Door, 2-2</li><li>Rotor Chamber, 2-2</li><li>Drive, 2-2</li><li>Friction Reduction System (FRS), 2-3</li><li>Temperature Sensing and Control, 2-3</li><li>Overtemp System, 2-3</li></ul> Name Rating Plate, 2-3
	Controls and Indicators, 2-3 <ul style="list-style-type: none"><li>Power Switch, 2-3</li><li>Control Panel, 2-4</li></ul>
<b>CHAPTER 3:</b>	Introduction, 3-1
	Summary of Avanti J-26XP Run Procedures, 3-2
	Section and Loading, 3-3
	Entering Run Parameters, 3-4 <ul style="list-style-type: none"><li>Selecting a Rotor, 3-4</li><li>Setting Run Speed, 3-4</li><li>Setting Run Time, 3-5</li><li>Setting Run Temperature, 3-7</li><li>Setting Acceleration and Deceleration Rates, 3-7</li><li>Setting Up an Elutriation Run, 3-9</li><li>Starting a Run, 3-11</li></ul>
	Changing Parameters During a Run, 3-12 <ul style="list-style-type: none"><li>Changing Time Settings, 3-12</li></ul>
	Stopping a Run, 3-12
	Unloading the Centrifuge, 3-13
<b>CHAPTER 4:</b>	Introduction, 4-1
	User Messages, 4-1
	Accessing the Rotor in Case of Power Failure, 4-5
	JCF-Z Rotor Identification, 4-9
<b>CHAPTER 5:</b>	Introduction, 5-1
	Maintenance, 5-1 <ul style="list-style-type: none"><li>Cleaning, 5-2</li><li>Decontamination, 5-3</li><li>Sterilization and Disinfection, 5-3</li><li>Replacing the Air Filter, 5-4</li></ul>
	Circuit Breaker and Fuses, 5-5



Storage and Transport, 5-5

Storage, 5-5

Returning a Centrifuge, 5-5

Supply List, 5-6

Replacement Parts and Supplies, 5-6

**APPENDIX A:** Introduction, A-1

Avanti® J Series Centrifuge Warranty, Warranty-1

# Illustrations

- 1.1 Single-Phase Electrical Requirements, 1-9
- 1.2 Three-Phase “Y” Electrical Requirements, 1-9
- 1.3 Correct and Incorrect Three-Phase Power Configurations, 1-10
- 1.4 Rear View and Dimensions, 1-12
- 1.5 Checking the Rotor for Drive Pins, 1-13
- 2.1 The Power Switch, 2-4
- 2.2 The Control Panel, 2-4
- 3.1 Acceleration and Deceleration Settings Graph, 3-8
- 3.2 Elutriation Controls, 3-9
- 4.1 Emergency Door Release Latch Access, 4-5
- 4.2 Manual Door Release, 4-6
- 4.3 Venting the Chamber Vacuum, 4-8
- 4.4 Front Panel Retaining Strip, 4-9

# Tables

1.1	Nominal Supply Voltage Ratings for the Avanti J-26XP, 1-8
1.2	Required Wire Connections, 1-10
3.1	Acceleration Settings, 3-7
3.2	Deceleration Settings, 3-8
4.1	Diagnostic Message Chart, 4-2



## Certification

---

To ensure full system quality, Beckman Coulter Avanti® J-26XP centrifuges are manufactured in a registered ISO 9001 or 13485 facility. They have been designed and tested to be compliant (when used with Beckman Coulter rotors) with the laboratory equipment requirements of applicable regulatory agencies. Declarations of conformity and certificates of compliance are available at [www.beckmancoulter.com](http://www.beckmancoulter.com).

## Scope of This Manual

---

This manual is designed to familiarize centrifuge users and site engineers with the Avant J-26XP centrifuge, its functions, specifications, operation, and routine care and maintenance. We recommend that you read this entire manual, especially the *Safety Notice* and all safety-related information, before operating the instrument or performing instrument maintenance.

- *CHAPTER 1, Specifications and Preinstallation Requirements* contains system specifications and instructions for preparing your site for centrifuge installation.
- *CHAPTER 2, Description* contains an overall description of the centrifuge, including a description of system controls and indicators.
- *CHAPTER 3, Operation* summarizes procedures for operating the centrifuge.
- *CHAPTER 4, Troubleshooting* lists system diagnostic messages, together with probable causes and user-performed corrective actions.
- *CHAPTER 5, Care and Maintenance* contains procedures for routine maintenance, as well as a brief list of supplies and replacement parts.
- *APPENDIX A* contains a procedure to use when temperature control within  $\pm 1^{\circ}\text{C}$  is required.

**NOTE** If the centrifuge is used in a manner other than specified in this manual, the safety and performance of this equipment could be impaired. Further, the use of any equipment other than that recommended by Beckman Coulter has not been evaluated for safety. Use of any equipment not specifically recommended in this manual is the sole responsibility of the user.

## Conventions

---

Certain symbols are used in this manual to call out safety related and other important information. These international symbols may also be displayed on the centrifuge and are reproduced on the inside back cover of the manual.

### Typographic Conventions

Certain typographic conventions are used throughout this manual to distinguish names of user interface components, such as keys and displays.

- Control knob names (for example, **ROTOR** and **SPEED**) appear in bold type.
- Key names (for example, **START** and **STOP**) appear in bold type.
- Display field names (for example, **TEMP°C** or **SPEED**) appear in bold type.

### CFC-Free Centrifugation

---

To ensure minimal environmental impact, no CFCs are used in the manufacture or operation of the Avanti J-26XP centrifuge.

### Radio Interference

---

This instrument has been tested and found to comply with the limits for a Class A digital device, pursuant to Part 15 of FCC Rules. These limits are designed to provide reasonable protection against harmful interference when the equipment is operated in a commercial environment. This equipment generates, uses, and can radiate radio frequency energy and, if not installed and used in accordance with this instruction manual, may cause interference to radio communications. Operation of this equipment in a residential area may cause interference, in which case the user will be required to correct the interference at his own expense.

### Canadian Regulations

This digital apparatus does not exceed the Class A limits for radio noise emissions from digital apparatus as set out in the radio interference regulations of the Canadian Department of Communications.

Le présent appareil numérique n'émet pas de bruits radioélectriques dépassant les limites applicables aux appareils numériques de Classe A prescrites dans le règlement sur le brouillage radioélectrique édicté par le Ministère des Communications du Canada.

## Recycling Label

---



This symbol is required in accordance with the Waste Electrical and Electronic Equipment (WEEE) Directive of the European Union. The presence of this marking on the product indicates:

1. The device was put on the European market after August 13, 2005 and
2. The device is not to be disposed via the municipal waste collection system of any member state of the European Union.

It is very important that customers understand and follow all laws regarding the proper decontamination and safe disposal of electrical equipment. For Beckman Coulter products bearing this label please contact your dealer or local Beckman Coulter office for details on the take back program that will facilitate the proper collection, treatment, recovery, recycling and safe disposal of the device.





# Specifications and Preinstallation Requirements

## Specifications

Only values with tolerances or limits are guaranteed data. Values without tolerances are informative data, without guarantee.

## Control Features

Specifications	Description
<b>Speed</b>	<ul style="list-style-type: none"> <li>• <i>Setting range:</i> <ul style="list-style-type: none"> <li>— 100 to 26 000 rpm (in 100-rpm increments below 10 000 rpm, 500-rpm increments above 10 000 rpm), or equivalent RCF (in <math>100 \times g</math> increments)</li> </ul> </li> <li>• <i>Elutriation speed setting range:</i> <ul style="list-style-type: none"> <li>— 0 to 5 000 rpm (in 10-rpm or <math>10 \times g</math> increments)</li> </ul> </li> <li>• <i>Speed display:</i> <ul style="list-style-type: none"> <li>— from 0 to 10 000 rpm, display indicates actual rotor speed <math>\pm 10</math> rpm; from 10 000 to 26 000 rpm, indicates actual rotor speed <math>\pm 0.1\%</math>, or equivalent RCF</li> </ul> </li> </ul>
<b>Time</b>	<ul style="list-style-type: none"> <li>• <i>Setting range:</i> <ul style="list-style-type: none"> <li>— to 180 minutes or continuous (hold)</li> </ul> </li> <li>• <i>Time display:</i> <ul style="list-style-type: none"> <li>— Indicates time remaining (timed run) or time elapsed (hold run)</li> </ul> </li> </ul>
<b>Temperature</b>	<ul style="list-style-type: none"> <li>• <i>Setting range:</i> <ul style="list-style-type: none"> <li>— <math>-10</math> to <math>+40^{\circ}\text{C}</math> (in <math>1^{\circ}\text{C}</math> increments)</li> </ul> </li> <li>• <i>Accuracy:</i> <ul style="list-style-type: none"> <li>— rotor temperature controlled to within <math>\pm 2^{\circ}\text{C}</math> of set temperature (after equilibration)<sup>a</sup></li> </ul> </li> <li>• <i>Ambient temperature range:</i> <ul style="list-style-type: none"> <li>— <math>16</math> to <math>38^{\circ}</math> (<math>60</math> to <math>100^{\circ}\text{F}</math>)<sup>b</sup></li> </ul> </li> <li>• <i>Cooling fluid:</i> <ul style="list-style-type: none"> <li>— refrigerant 404A (HFC)</li> </ul> </li> </ul>

Specifications	Description
Acceleration	maximum or slow
Deceleration	maximum, slow, or off

- a. During transient conditions, such as acceleration and deceleration, rotor temperature may be outside this range. Refer to applicable rotor manuals for specific rotor operating range information.
- b. To reach temperatures above ambient, the centrifuge is dependent on the frictional heat generated inside the chamber during operation. At low run speeds or low ambient temperatures, the centrifuge may not be able to achieve some higher temperatures.

## Operational Features

Specifications	Description
Door	6.1-cm (2.4-in.) thick structural foam with steel plate
Rotor Chamber Diameter	51.3 cm (20 in.)
Friction Reduction System (FRS)	190 mm (7.5 in.) Hg

## Physical Data

Specification	Description
Width	71 cm (28 in.)
Depth	<ul style="list-style-type: none"> <li>• 86 cm (34 in.)</li> <li>• including air diverter extending from back panel                             <ul style="list-style-type: none"> <li>— 102 cm (40.25 in.)</li> </ul> </li> </ul>
Height	<ul style="list-style-type: none"> <li>• with door closed                             <ul style="list-style-type: none"> <li>— 86 cm (34 in.)</li> </ul> </li> <li>• to top of control head                             <ul style="list-style-type: none"> <li>— 116 cm (45.5 in.)</li> </ul> </li> <li>• to top of open door                             <ul style="list-style-type: none"> <li>— 149 cm (58.7 in.)</li> </ul> </li> </ul>
Weight	290 kg (640 lb)
Clearances (for adequate ventilation)	<ul style="list-style-type: none"> <li>• sides                             <ul style="list-style-type: none"> <li>— 7.6 cm (3 in.)</li> </ul> </li> <li>• back (place air diverter against the wall)                             <ul style="list-style-type: none"> <li>— 16 cm (6.25 in.)</li> </ul> </li> </ul>
Surface Finish	polyester control panel with polycarbonate coating overlay; polyurethane enamel on door and covers; acrylic baking enamel on other surfaces

Specification	Description
<b>Electrical Requirements</b>	<ul style="list-style-type: none"> <li>200/208/240-V, single-phase instrument                             <ul style="list-style-type: none"> <li>— 180–264 VAC, 30 A, 50/60 Hz</li> </ul> </li> <li>230-V, single-phase instrument                             <ul style="list-style-type: none"> <li>— 180–264 VAC, 30 A, 50 Hz</li> </ul> </li> <li>220/380-V plus neutral, three-phase<sup>a</sup> instrument                             <ul style="list-style-type: none"> <li>— 313–457 VAC plus neutral, 16 A, 50 Hz</li> </ul> </li> </ul>
<b>Electrical Supply</b>	Class I
<b>Maximum Heat dissipation into Room Under Steady-State Conditions</b>	2.0 kW (6900 BTu/h)
<b>Humidity restrictions</b>	<95% (noncondensing)
<b>Noise Level 0.91 m (3 ft) in front of instrument at 26 000 rpm</b>	57 dBA
<b>Installation (overvoltage) Category</b>	II
<b>Pollution Degree</b>	2 <sup>b</sup>

a. Unbalanced three-phase. Split for single-phase operation internally.

b. Normally, only nonconductive pollution occurs; occasionally, however, a temporary conductivity caused by condensation must be expected.

## Available Rotors

Refer to the applicable rotor manual for complete rotor descriptions.

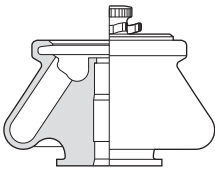
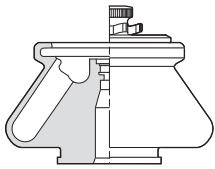
Rotor Profile	Description	Rotor Code	Max RPM <sup>a</sup>	Max RCF (× g)	Max Capacity	Rotor Manual Number
	JA-30.50 Ti <sup>b</sup> Fixed Angle, 34° (8 place) $r_{\max} = 108$ mm	30.50	26 000 <sup>c</sup>	81 800	8 × 50 mL	J-TB-070
	JA-25.50 Ti Fixed Angle, 34° (8 place) <sup>d</sup> $r_{\max} = 108$ mm	25.50	25 000	75 600	8 × 50 mL	J-TB-056

**Specifications and Preinstallation Requirements**  
Available Rotors

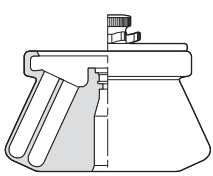
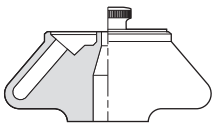
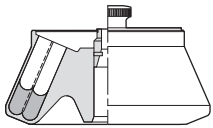
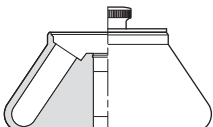
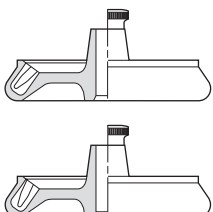
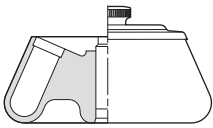
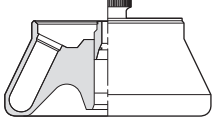
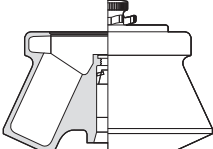
Rotor Profile	Description	Rotor Code	Max RPM <sup>a</sup>	Max RCF (× g)	Max Capacity	Rotor Manual Number
	JA-25.15 Ti Fixed Angle, 25° (24 place) <sup>d</sup> $r_{max} = 106$ mm (outer row) $r_{max} = 86$ mm (inner row)	25.15	25 000	74 200 60,200	24 × 15 mL	J-TB-057
	JA-21 Fixed Angle, 40° (18 place) $r_{max} = 102$ mm	21	21 000	50 400	18 × 10 mL	J-TB-002
	JA-20.1 Fixed Angle, 23° (32 Place) $r_{max} = 115$ mm (outer row) $r_{max} = 98$ mm (inner row)	20.1	20 000	51 500 43 900	32 × 15 mL	J-TB-022
	JA-20 Fixed Angle, 34° (8 place) $r_{max} = 108$ mm	20	20 000	48 400	8 × 50 mL	J-TB-003
	JA-18.1 Fixed Angle (24 place) 45° adapter $r_{max} = 116$ mm 25° adapter $r_{max} = 112$ mm	18.1	18 000 17 000	42 100 36 300	24 × 1.8 mL 24 × 1.8 mL	J-TB-037
	JA-18 Fixed Angle, 23° (10 place) $r_{max} = 132$ mm	18	18 000	47 900	10 × 100 mL	J-TB-035
	JA-17 Fixed Angle, 25° (14 place) $r_{max} = 132$ mm	17	17 000	39 800	14 × 50 mL	J-TB-017
	JLA-16.250 Fixed Angle, 25° (6 place) $r_{max} = 134$ mm	16.250	16 000	38 400	6 × 250 mL	J-TB-072

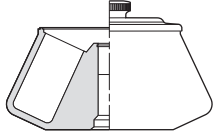
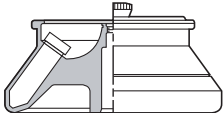
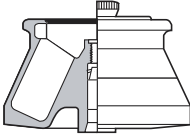
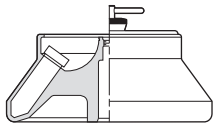
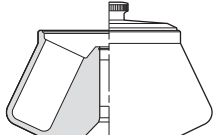
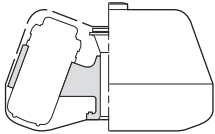
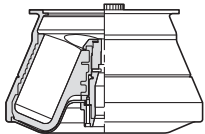
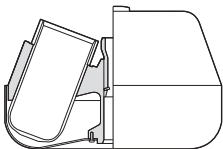
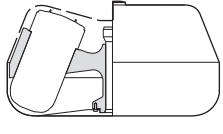
Rotor Profile	Description	Rotor Code	Max RPM <sup>a</sup>	Max RCF ( $\times g$ )	Max Capacity	Rotor Manual Number
	JA-14 Fixed Angle, 25° (6 place) $r_{\max} = 137$ mm	14	14 000	30 100	6 $\times$ 250 mL	J-TB-004
	F14BCI-14x50cy Fixed Angle, 34° (14 place) $r_{\max} = 153$ mm	F50C	14 000	33 500	14 $\times$ 50 mL	—
	F14BCI-6x250y Fixed Angle, 23° (6 place) $r_{\max} = 134$ mm	F250	14 000	30 000	6 $\times$ 250 mL	—
	JA-12 Fixed Angle, 35° (12 place) $r_{\max} = 144$ mm	12	12 000	23 200	12 $\times$ 50 mL	J-TB-051
	JA-10 Fixed Angle, 25° (6 place) $r_{\max} = 158$ mm	10	10 000	17 700	6 $\times$ 500 mL	J-TB-006
	JLA-10.500 Fixed Angle, 20° (6 place) $r_{\max} = 166$ mm	10.500	10 000	18 600	6 $\times$ 500 mL	J-TB-048
	F10BCI-6x500y Fixed Angle, 23° (6 place) $r_{\max} = 158$ mm	F500 (previously 10.1)	10 000	17 696	6 $\times$ 500 mL	—
	JLA-9.1000 Fixed Angle, 20° (4 place) $r_{\max} = 185$ mm	9.1000	9 000	16 800	4 $\times$ 1000 mL	J-TB-073
	JLA-8.1000 Fixed Angle, 20° (6 place) $r_{\max} = 222.8$ mm	8.1000	8 000	15 970	6 $\times$ 1000 mL	J-TB-073

**Specifications and Preinstallation Requirements**  
Available Rotors

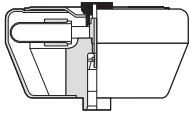
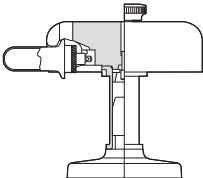
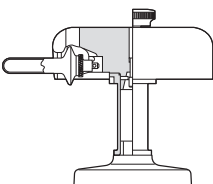
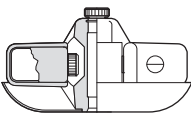
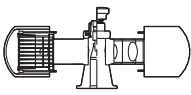
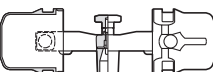
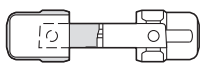
Rotor Profile	Description	Rotor Code	Max RPM <sup>a</sup>	Max RCF ( $\times g$ )	Max Capacity	Rotor Manual Number
	JS-13.1 Swinging Bucket (6 place) $r_{\max} = 140$ mm	13.1	13 000	26 500	6 $\times$ 50 mL	J-TB-036
	JS-24.38 Swinging Bucket (6 place) $r_{\max} = 161$ mm	24.38	10 000 <sup>e</sup>	18 000	6 $\times$ 38.5 mL	J-TB-058
	JS-24.15 Swinging Bucket (6 place) $r_{\max} = 171.3$ mm	24.15	10 000 <sup>e</sup>	19 200	6 $\times$ 15 mL	J-TB-058
	JS-7.5 S Swinging Bucket (4 place) $r_{\max} = 165$ mm	7.5	7 500	10 400	4 $\times$ 50 mL	J-TB-007
	JS-5.3 Swinging Bucket (4 place) $r_{\max} = 194.8$ mm	5.3	5 300	6 130	24 microplates 8 deep-well plates 4 square-well plates	J-TB-089
	JS-4.3 Swinging Bucket (4 place) $r_{\max} = 204$ mm	4.3	4 300	4 220	4 $\times$ 750 mL	J-TB-050
	JS-4.0 Swinging Bucket (4 place) $r_{\max} = 226$ mm	4.0	4 000	4 050	4 $\times$ 1 liter 4 blood bags 12 microplates 148 RIA tubes	J6-TB-006

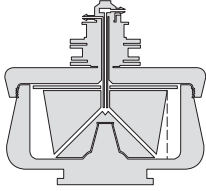
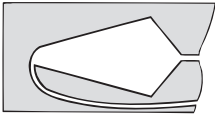
Rotor Profile	Description	Rotor Code	Max RPM <sup>a</sup>	Max RCF (× g)	Max Capacity	Rotor Manual Number
	JCF-Z Continuous Flow/ Zonal Rotor <sup>f</sup>	JCFZ	20 000	39 900	660 mL (standard core) 1250 mL (large core) 240 mL (small core)	JCFZ-IM
	JE-5.0 Elutriation Rotor $r_{max}$ large chamber = 168 mm standard chamber = 125 mm Sanderson chamber = 126 mm	5.0	5 000	4 700 3 500 4 230	40 mL 4.0 mL 5.5 mL	JE5-IM

- Maximum speeds are based on a solution density of 1.2 g/mL with the following exceptions: the JA-18.1 rotor is rated for a density of 1.4 g/mL; the JCF-Z rotor is rated for a density of 1.45 g/mL; and the JE-5.0 rotor is rated for a density of 3 g/mL.
- Temperature performance for the JA-30.50 Ti rotor in the Avanti J-26XP is as follows: 15°C minimum at 26 000 rpm (at 30°C ambient); 4°C minimum at 21 500 rpm (30°C ambient).
- Maximum speed for the JA-30.50 Ti rotor is 26 000 rpm in the Avanti J-26XP centrifuge, and 30 000 rpm in the Avanti J-30I centrifuge.
- Temperature performance for the JA-25.50 and JA-25.15 rotors in the Avanti J-26XP is as follows: 10°C minimum at 25 000 rpm (at 30°C ambient); 4°C minimum at 21 500 rpm (30°C ambient).
- Maximum speed for the JS-24.38 and JS-24.15 rotor is 10 000 rpm in the Avanti J-26XP centrifuge, and 24 000 rpm in the Avanti J-30I centrifuge.
- In the Avanti J-26XP, the JCF-Z Continuous Flow/Zonal Rotor can be used in the continuous flow and reorienting gradient zonal configurations only.

## Preinstallation Requirements

*Do not attempt to install this instrument. Its purchase price includes installation by Beckman Coulter personnel. Installation by anyone other than an authorized Beckman Coulter representative invalidates any warranty covering the instrument.*

Preinstallation requirements have been sent prior to shipment of the instrument. The following information is provided in case the centrifuge must be relocated.

The centrifuge will be installed upon initial purchase by a Beckman Coulter Field Service representative after preinstallation requirements for power and site preparation have been met. The following equipment is required for preinstallation:

- Voltmeter
- For single phase centrifuges: two 30-ampere circuit breakers
- For three phase centrifuges: three 16-ampere circuit breakers

- Power receptacle (see [Figure 1.1](#) or [Figure 1.2](#))
- Drill for drilling holes in the floor for installation of anchoring kit bolts (see [Securing the Centrifuge to the Floor](#), later in this section). A 9.5 mm (<sup>3</sup>/<sub>8</sub>-inch) drill is required for concrete floors. A 6.4 mm (<sup>1</sup>/<sub>4</sub>-inch) drill is required for wood floors.

## Electrical Requirements

Power to the centrifuge should originate directly from a main power line transformer at a power source known to be clear of erratic loads, spikes, and electromagnetic interference. Make sure that there are properly rated thermal circuit breakers at the service panel to protect the centrifuge circuit. If fuses must be used instead of the specified circuit breakers, the fuses may require a rating of greater than 30 amperes (for single-phase centrifuges) or greater than 16 amperes (for three-phase centrifuges).

Terminate the open end of the harmonized cord with a certified single- or three-phase connector suitable for the power supplied in the country of intended use (see [Table 1.1](#)). Install only one centrifuge per circuit.

**Table 1.1** Nominal Supply Voltage Ratings for the Avanti J-26XP

Nominal Instrument Voltage Rating	Instrument Part Number	Instrument Part Number (Elutriation System)	Nominal Supply Frequency	Power Cord and Plug Description
Single-phase, 200/208/240 V	393124	393130	180–264 V, 50/60 Hz, 30 A	permanently attached three-wire UL/CSA-approved cord with NEMA type 6-30P plug
Single-phase, 230 V	393125	393131	180–264 V, 50 Hz, 30 A	permanently attached three-wire CENELEC harmonized cord without plug
Three-phase, 220/380 V + Neutral <sup>a</sup>	393126	393132	313–457 V, plus neutral, 50 Hz, 16 A	permanently attached five-wire CENELEC harmonized cord without plug

a. Unbalanced three-phase. Split for single-phase operation internally.

To ensure safety, connect the instrument to a remote emergency switch (preferably outside the room where the centrifuge is housed, or adjacent to the exit from that room), to disconnect the centrifuge from the main power source in case of a malfunction.



**To reduce the risk of electrical shock, this equipment uses a three-wire or five-wire electrical cord and plug to connect the centrifuge to earth-ground. To preserve this safety feature, make sure that the matching wall outlet receptacle is properly wired and earth-grounded.**

Prior to instrument purchase, the power configuration should be determined and the appropriate instrument ordered.



## Single and Three-Phase Power Connections

Figure 1.1 shows the power connection for single-phase centrifuges, including earth-ground and two power leads with 30-ampere circuit breakers. Figure 1.2 shows the power connection for three-phase centrifuges, including earth-ground and three power leads with minimum 16-ampere circuit breakers and common neutral connection. Table 1.2 contains wiring information.

**Figure 1.1** Single-Phase Electrical Requirements

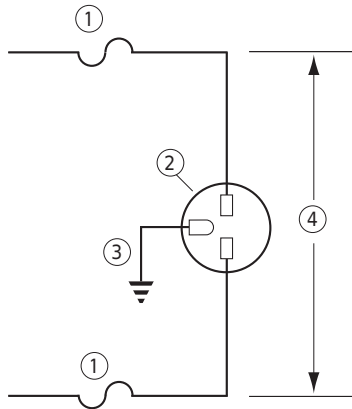

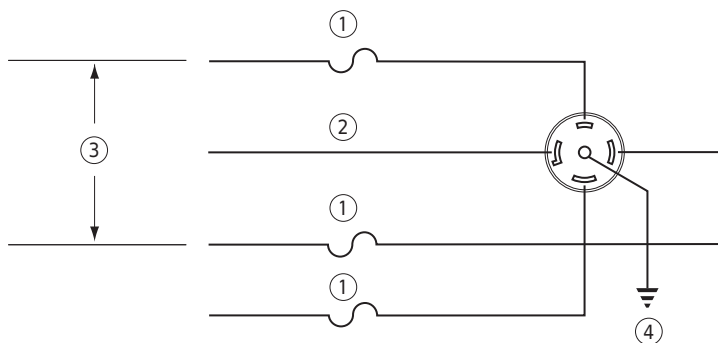

- |   |                          |
|---|--------------------------|
| 1. 30-ampere Circuit Breaker  | 3. Earth-Ground          |
| 2. Wall Outlet: Hubell 9930,<br>Bryant 96-30-FR, or Equivalent<br>(NEMA 6-30 R) | 4. Measured Line Voltage |

**Figure 1.2** Three-Phase “Y” Electrical Requirements



- |                              |   |
|------------------------------|---|
| 1. 16-ampere Circuit Breaker | 3. Measured Line Voltage Phase to Phase |
| 2. Neutral                   | 4. Earth-Ground                         |

**Table 1.2** Required Wire Connections

Wire Insulation Color	Terminal	Symbol	
		Harmonized	North American
Green/Yellow	Earth ground		
Light Blue	Neutral	N	L
Brown	Live or Line	L	L
Black (three-phase connections only)	Live or Line (qty 2)	L	—

### Additional Requirements for Three-Phase Power Connections

For three-phase power service to the centrifuge, use the “Y” connected configuration shown in [Figure 1.3](#). Also note the following information:

- The steady state current draw of the centrifuge can be as high as 12 amperes per phase, depending on the voltage.
- Inrush current to the centrifuge is 100 amperes for up to 2 seconds during the refrigeration start period. Circuit breakers, whether thermal or magnetic actuating, must be a “motor start” delay type.
- The centrifuge can tolerate a drop of 15 volts during the start period at low line voltage (see [Figure 1.3](#) for the acceptable voltage ranges). The mains power for the centrifuge must be of sufficient wire gauge to provide this condition. The wire gauge required at a particular site must be determined by a facilities engineer at that site.

**Figure 1.3** Correct and Incorrect Three-Phase Power Configurations

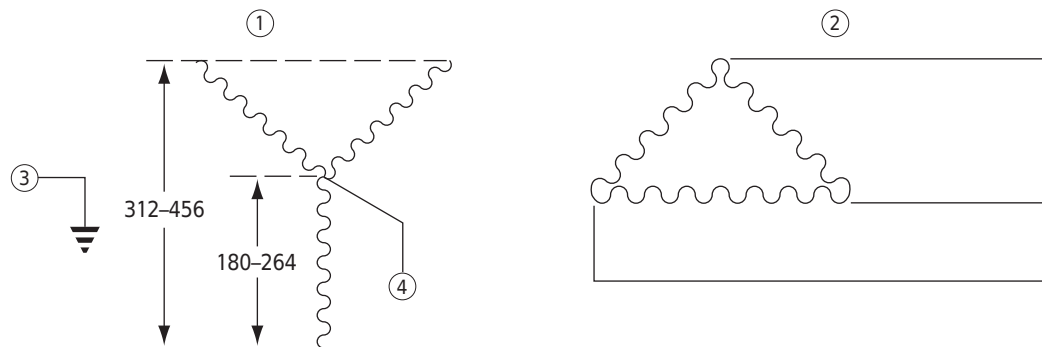

1. Correct Configuration “Y”
2. Incorrect Configuration “Delta”
3. Safety Ground
4. Circuit Common (Neutral)

## Space and Location Requirements

- 1 Locate the instrument on a clean, level floor.
- 2 Select a location away from heat-producing laboratory equipment.
  - If ambient temperature exceeds 38°C (100°F), premature component failure may result.
- 3 In addition to space for the centrifuge, allow a 7.7-cm (3-in.) clearance on each side of the centrifuge and a 16-cm (6.25-in.) clearance behind the centrifuge for air circulation.
  - The centrifuge must have adequate air ventilation to ensure compliance to local requirements for vapors produced during centrifuge operation.
- 4 Position the centrifuge so that the air diverter, shown in [Figure 1.4](#), touches the wall behind the centrifuge.
  - a. Place the power cord to one side of the air diverter.
  - b. To avoid damaging the power cord when installing or moving the centrifuge, be sure to move the cord out of the way before pushing the centrifuge towards the wall.

 **WARNING**

**Do not place the centrifuge near areas containing flammable reagents or combustible fluids. Vapors from these materials could enter the instrument's air system and be ignited.**

## Securing the Centrifuge to the Floor

Avanti J series centrifuges are certified to meet the requirements of the European CE mark. To meet these requirements, the centrifuge must be secured to the floor using the anchoring hardware shipped with the instrument. This will prevent the centrifuge from moving in the unlikely event of a rotor mishap.

Complete instructions for installing the anchoring kit are packaged with the hardware, which is shipped with the centrifuge. The instructions (publication J325-TB-003) include a full-size template to be used as a guide for drilling holes in the floor. Refer to this document for additional installation instructions.

**NOTE** Beckman Coulter representatives are not equipped to drill holes in your floor. The holes must be drilled *before* your scheduled installation.

Figure 1.4 Rear View and Dimensions

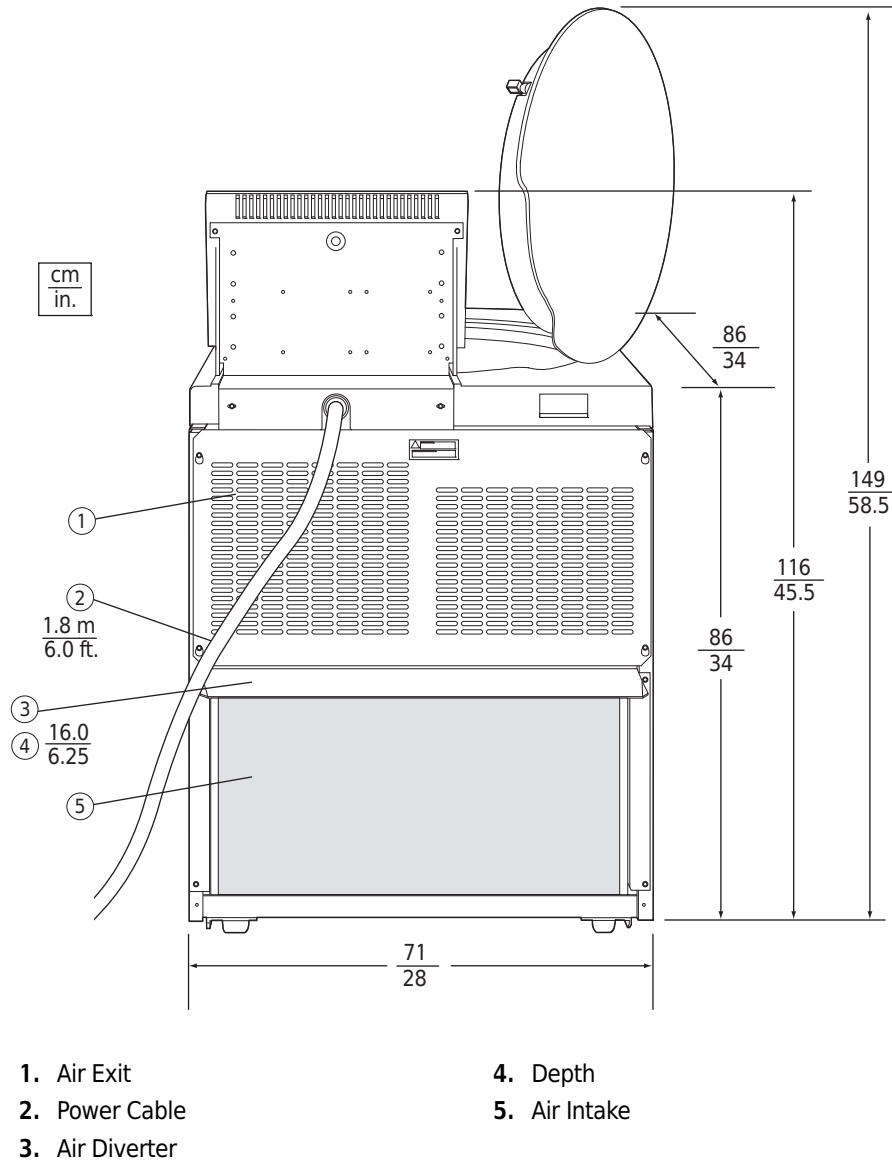

### Bio-Safety Level 3 Installation

For laboratories with epoxy aggregate (resinous) floors, such as BSL-3 labs, a non-invasive installation kit (PN 393316) is available. The kit which consists of an adhesive-backed mounting plate, is CSA certified for use on epoxy aggregate floors only.

### Non-Invasive Centrifuge Restraint System for Vinyl Floors

For laboratories with vinyl tile floors or vinyl seamless floors, a non-invasive installation kit (PN A84005) is available. The kit which consists of an adhesive-backed mounting plate, is CSA certified for use on vinyl floors only.

## Using J2 Series Rotors in the Avanti J

**CAUTION**

Do not use the Beckman Coulter JA-10, JS-7.5, JA-14, or JS-13 rotors in the Avanti J-26XP centrifuge before reading this information.

### Checking for Rotor Drive Pins

Rotors used in Avanti J series centrifuges must have drive pins in the rotor drive hole (see [Figure 1.5](#)). These drive pins engage with the centrifuge spindle hub to ensure that the rotor does not slip during acceleration. Some Beckman Coulter rotors, including the JA-10, the JS-7.5, the JA-14, and the JS-13, have been manufactured without drive pins because pins were not needed when these rotors were used in J2 series centrifuges.

**Figure 1.5** Checking the Rotor for Drive Pins

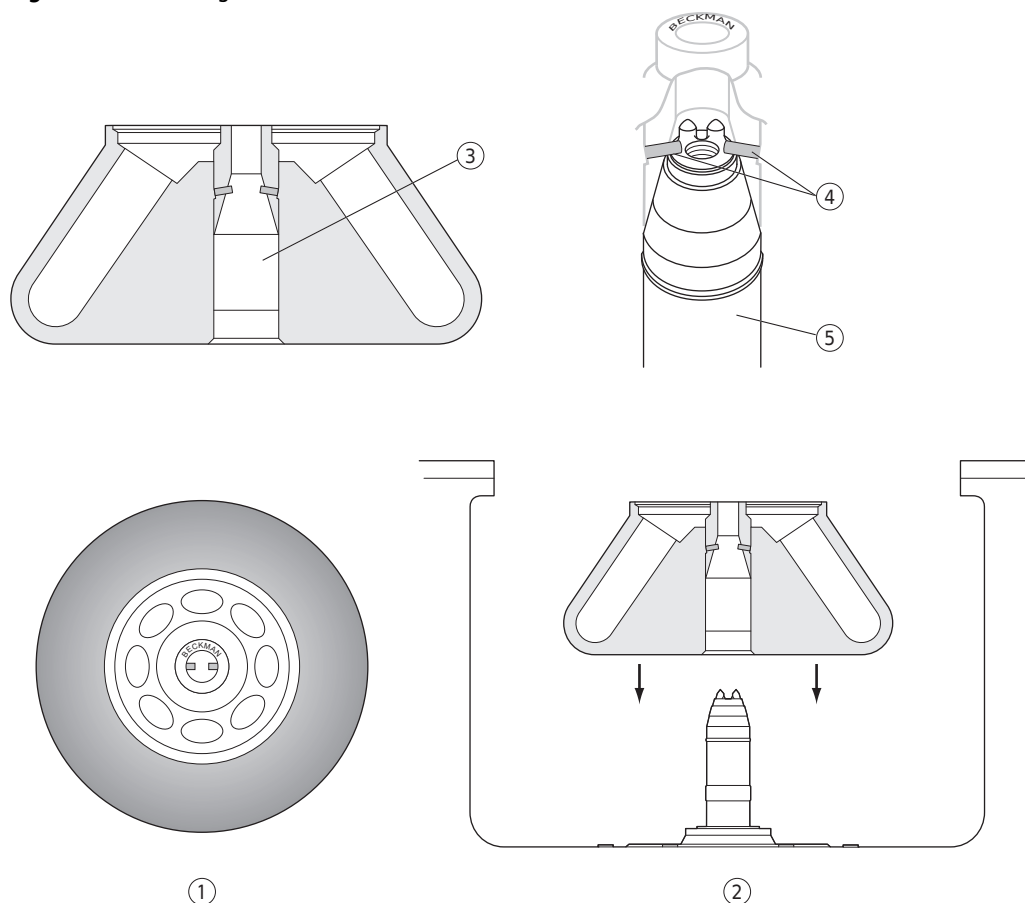

1. Top View
2. Side View
3. rotor Drive Hole
4. Drive Pins (Angled pins shown; pins can also be vertical or horizontal.)
5. Drive Spindle Assembly

The rotor pins are positioned parallel to the **Beckman** name engraved at the center of the rotor body (see [Figure 1.5](#)). Knowing the pin orientation before you install the rotor will help to ensure that you position the rotor properly on the hub, minimizing the chance of hub damage.

*Check all J2 series rotors for drive pins before using them in an Avanti J series centrifuge and do not use rotors without drive pins in the Avanti J.* To check for drive pins, hold the rotor up or turn it on its side and look into the drive hole. If you do not see two metal pins in the hole, do not use the rotor in the Avanti J. Call your local Beckman Coulter office for information on returning the rotor to the factory for upgrading.

## Using the JA-18 Rotor

In Avanti J series centrifuges, the JA-18 rotor must be run with the lid attached. See the JA-18 rotor manual (publication J-TB-035) for complete rotor usage instructions.

## Using the JCF-Z Continuous Flow/Zonal Rotor

### Zonal Bracket Kits

A special bracket and mounting hardware are required when the JCF-Z Continuous Flow/Zonal Rotor is used. These parts are contained in the Zonal Bracket Kit (part number 366431). The Zonal Bracket Kit includes a bracket, mounting hardware, and assembly instructions. This kit is for use with Cole-Parmer tubing size 16 (6.4 mm [<sup>1</sup>/<sub>4</sub>-in.] O.D.), the tubing size most commonly used with the JCF-Z rotor.

Two additional kits are available, one which contains adapters for size 14 tubing (4.8 mm [<sup>3</sup>/<sub>16</sub>-in.] O.D.) and one which contains adapters for size 15 tubing (9.6 mm [<sup>3</sup>/<sub>8</sub>-in.] O.D.). If you wish to use either of these sizes of tubing, you will need to purchase one of these kits in addition to the basic kit (366431).

See [Replacement Parts and Supplies](#) in [CHAPTER 5](#) for a complete list of Zonal Bracket Kit part numbers and kit contents.

### Ensuring Correct JCF-Z Continuous Flow/Zonal Rotor Identification

The centrifuge's rotor identification system can, under two specific conditions, misidentify the JCF-Z continuous flow/zonal rotor. These conditions and corrective actions are listed below.

**NOTE** JCF-Z rotors manufactured after March, 1997, contain special magnets that ensure correct rotor identification in Avanti J series centrifuges. We recommend that older JCF-Z rotors be returned to the Beckman Coulter factory for addition of the magnets before use in the Avanti J-26XP. Call Beckman Coulter Field Service\* for more information.

---

\* In the United States, call 1-800-742-2345. Outside the US, contact your local Beckman Coulter office.

The following information pertains to JCF-Z rotors manufactured before March, 1997, and to JCF-Z rotors that have not been modified at the factory.

- When the bearings in the JCF-Z rotating seal assembly get old or worn, the resulting “drag” on the bearings changes the rotor’s dynamic properties, making them similar to those of several Beckman Coulter fixed angle rotors. If rotor misidentification occurs when your JCF-Z rotor is used, first perform three runs from 0 to 5000 rpm and back to 0 rpm. If rotor misidentification recurs, replace the bearings. See the JCF-Z rotor instruction manual (publication JCFZ-IM) for bearing replacement instructions. Be sure to follow instructions in the next paragraph below for “wearing in” the bearings.
- On the first few uses of a new JCF-Z rotor, or when the bearings have been replaced in an older JCF-Z rotor, lubrication has not yet been thoroughly distributed around the bearings in the bearing housing. The excess lubrication produces drag on the bearings, which can change the rotor’s dynamic properties enough to cause rotor misidentification. To “wear in” the bearings and distribute the lubrication, perform three runs from 0 to 5000 rpm and back to 0 rpm.

**NOTE** If the JCF-Z rotor is misidentified, the run speed will be limited to the maximum speed for the identified rotor. (The maximum speed for the JCF-Z rotor is 20 000 rpm.)





# Description

*This section describes the Avanti J-26XP centrifuge components and their functions. It also describes system safety features and centrifuge controls and displays. Refer to the applicable rotor manual for rotor descriptions.*

## Centrifuge Function and Safety Features

---

### Centrifuge Function

The Avanti J-26XP is a refrigerated centrifuge that generates centrifugal forces required for a wide variety of applications. Together with the Beckman Coulter rotors designed for use in this centrifuge, applications include:

- Routine processing such as sample preparations, pelleting, extractions, purifications, concentrations, phase separations, and spin column and spin filter centrifugations.
- Rapid sedimentation of protein precipitates, large particles, and cell debris.
- Preparation of subcellular organelles such as mitochondria, nuclei, chloroplasts, and crude microsomes.
- Separation of blood cells and cellular components.
- Pelleting of prokaryotic and eukaryotic cells
- Gradient separation, for example, Ficoll-Hypaque\* and Percoll.\*
- Nucleic acid precipitation.
- Virus isolation.
- Bacteriophage isolation.

The Avanti J-26XP centrifuge is microprocessor-controlled, providing interactive operation.<sup>†</sup> The centrifuge features a brushless switched-reluctance drive motor,<sup>‡</sup> an automatic rotor identification system, FRS (friction reduction system) vacuum control circuitry, and a temperature control system with automatic temperature compensation unique for each compatible rotor.

---

\* Registered trademarks of Pharmacia AB.

† Avanti J-26XP software and firmware copyright ©2005 by Beckman Coulter, Palo Alto, CA, U.S.A.

‡ Manufactured under license from Switched Reluctance Drives Limited, Harrogate, U.K.

The user interface has a digital display, which can be toggled to show either actual centrifuge values or user-entered setup values, knobs for parameter entry, and touch keys. Diagnostic messages on the control panel will light to alert the operator to conditions that may need attention.

## Safety Features

Avanti J-26XP centrifuges have been designed and tested to operate safely indoors at altitudes up to 2 000 m (6 562 ft).

Safety features include the following.

- An electromechanical door lock system prevents operator contact with spinning rotors and prevents run initiation unless the door is shut and locked. The door locks when **START** is pressed, or when the **POWER** switch is turned off.
- A steel casing surrounds the rotor chamber to provide operator protection in the unlikely event of a rotor mishap.
- An automatic rotor identification system detects which rotor is installed and prevents the rotor from running above its maximum rated speed.
- An imbalance detector monitors the system during operation, causing automatic shutdown if rotor loads are severely out of balance.

## Housing and Door

The instrument control housing is made of aluminum and molded structural foam. The door and structural-foam cover panels are finished with polyurethane enamel. The control panel is covered by a protective overlay made of coated polycarbonate.

The door is opened by stepping on a foot pedal, which is located at the bottom right front of the instrument. The door is hinged at the back left to open at a 60-degree angle to the centrifuge side panels, providing clearance for loading and unloading of the centrifuge.

In the event of a power failure, the door can be manually unlocked for sample recovery (see [CHAPTER 4, Troubleshooting](#)).

## Rotor Chamber

The rotor chamber is made of stainless steel to resist corrosion. A rubber gasket around the chamber opening ensures sealing. (Instrument gaskets have not been qualified as bioseals for aerosol containment.)

## Drive

The drive spindle is directly driven by a brushless, high-torque, switched-reluctance motor. The instrument's resilient suspension minimizes disturbance of the sample during acceleration and deceleration, and reduces damage to the drive spindle if an imbalance occurs during centrifugation.

## Friction Reduction System (FRS)

The friction reduction system (FRS) uses a mechanical rotary vane vacuum pump to reduce chamber pressure to approximately one-quarter atmosphere (190 mm Hg). The pump turns on after the run is started, before rotor friction reaches a high level. When the required vacuum level is reached, the pump turns off. Vacuum in the chamber is vented during rotor deceleration.

## Temperature Sensing and Control

The temperature control system is cooled by circulation of a non-CFC-based refrigerant. The temperature control system is activated when the centrifuge power is on and when the door is closed.

A thermistor in the rotor chamber continuously monitors the chamber temperature. The system calculates the chamber temperature required to maintain the set rotor temperature,  $\pm 2^{\circ}\text{C}$ . Although the chamber temperature fluctuates during operation, the rotor's large mass keeps the sample temperature substantially constant. At the end of a run, the system continues controlling the temperature to prevent freezing or overheating (more than  $4^{\circ}\text{C}$  over set temperature) of the sample.

## Overtemp System

An overtemp (over temperature) system provides sample protection and safety for the user.

- During a run, if the system temperature rises  $4^{\circ}\text{C}$  above the set temperature, the **TEMP** diagnostic will light. The run will continue, unless stopped by the user. If the temperature rises  $8^{\circ}\text{C}$  above the set temperature, the system will shut down (using maximum brake).
- The system will always shut down (using maximum brake) if the system temperature reaches  $50^{\circ}\text{C}$ . The centrifuge cannot be restarted until the chamber has cooled.

## Name Rating Plate

---

The name rating plate is affixed to the rear of the centrifuge. Check that the line voltage agrees with the voltage listed on this name rating plate before connecting the centrifuge. Always mention the serial number and the model number shown when corresponding with Beckman Coulter regarding your centrifuge.

## Controls and Indicators

---

### Power Switch

The power switch is located below the control panel (see [Figure 2.1](#)). This two-position rocker switch (**I**, on; **O**, off) controls electrical power to the centrifuge.

Figure 2.1 The Power Switch

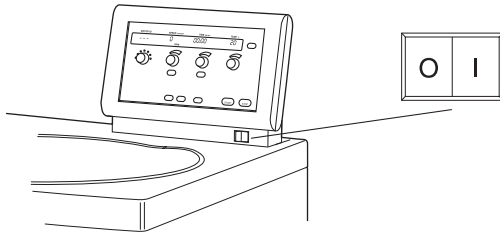

## Control Panel

The control panel (Figure 2.2) is mounted at an angle on the centrifuge top rear for easy visibility and access. It contains a digital display for actual and setup values, knobs and touch keys for parameter entry, and additional touch keys for system control.

Figure 2.2 The Control Panel

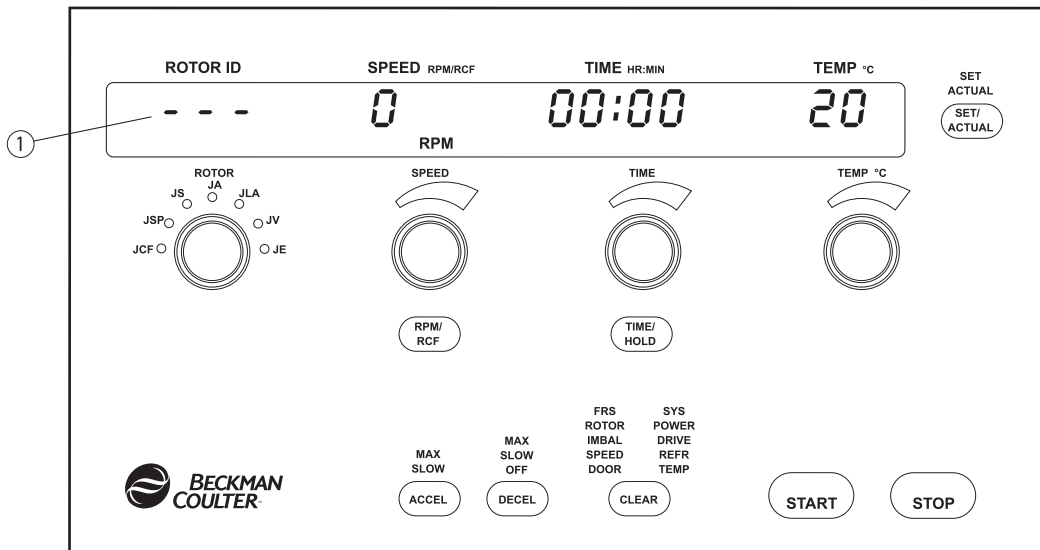

1. Digital Display

### Digital Display

The display shows current status of the instrument whenever the power is turned on.



- The display shows both actual centrifuge values and user-set parameters. The **SET/ACTUAL** key is used to toggle between the two views.
- During a run, actual values are displayed. If you turn a knob (other than the **TIME** knob) during operation, the display will change to show the set values. If no parameters are entered or changed for 5 seconds, the display will revert to showing actual values.
- During a timed run, the **TIME** display shows the *remaining run time in hours and minutes*. The **TIME** display begins counting down when **START** is pressed and continues counting down to 0, when deceleration begins. When the rotor decelerates to 0 rpm, **End** flashes in the **TIME** display.



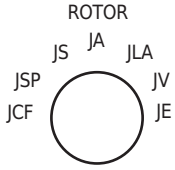

- When **HOLD** is selected (no run time is specified), the **TIME** display shows the *time elapsed since START was pressed*. After 3 hours (180 minutes) have elapsed, the timer will reset to 0 and continue counting elapsed time until **STOP** is pressed.

### Knobs and Touch Keys

The rotor name, speed, time, and temperature settings are entered by turning the appropriate knob until the required value is displayed.

Touch keys allow the user to start and stop the centrifuge, and to select speed mode (RPM or RCF), time mode (specific run length or hold for continuous operation), and acceleration and deceleration rates, and to toggle the display between set and actual values.

<p><b>ROTOR Knob</b></p> 	<p>Used to select the rotor in use. As the knob is turned, the name of each Beckman Coulter rotor that can be run in the centrifuge appears in succession in the <b>ROTOR ID</b> display, and the LED by each rotor type abbreviation (<b>JCF</b>: continuous flow rotors; <b>JSP</b>: special type rotors; <b>JS</b>: swinging bucket rotors; <b>JA</b>: fixed angle rotors; <b>JLA</b>: lightweight fixed angle rotors; <b>JV</b>: vertical tube rotors; <b>JE</b>: elutriator rotors) lights when appropriate.</p>
<p><b>SPEED Selection</b></p> 	<p>The <b>RPM/RCF</b> key is pressed to select the speed mode (RPM or RCF). After the mode is selected, the <b>SPEED</b> knob functions as follows.</p> <ul style="list-style-type: none"> <li>In <b>RPM</b> mode, each <b>SPEED</b> knob increment is 100 rpm at speeds up to 10 000 rpm. Above 10 000 rpm, each knob increment is 500 rpm.</li> <li>In <b>RCF</b> mode, at settings less than or equal to <math>3000 \times g</math>, each <b>SPEED</b> knob increment is equivalent to incrementing/decrementing the speed by <math>100 \times g</math>. At settings greater than <math>3000 \times g</math>, each <b>SPEED</b> knob increment is equivalent to incrementing/decrementing the speed by <math>250 \times g</math>.</li> <li>Speed increments for elutriator rotors are either 10 rpm or <math>10 \times g</math>.</li> </ul>

<p><b>TIME Selection</b></p> <p>TIME</p> 	<p>Two time modes are available. The <b>HR:MIN</b> mode is used for runs of specified lengths. The <b>HOLD</b> mode is used for continuous runs of unspecified lengths. The <b>HOLD</b> key is used to toggle between the two modes.</p> <p><b>In HR:MIN mode:</b></p> <ul style="list-style-type: none"> <li>• The <b>TIME</b> knob is used to set run time, which can be set up to 3 hours and 0 minutes (180 minutes).</li> <li>• Each <b>TIME</b> knob increment is 1 minute. A full turn of the knob equals 60 minutes.</li> <li>• The time setting can be changed during a run.</li> <li>• During a run, the time remaining in the run is displayed. When 0 is reached, the run ends and the rotor decelerates to a stop.</li> </ul> <p><b>In HOLD mode:</b></p> <ul style="list-style-type: none"> <li>• When <b>HOLD</b> mode is selected, the time display shows the word <b>HOLD</b>.</li> <li>• During a run, the time elapsed is displayed. When the display reaches 3 hours and 0 minutes, the system automatically resets the display to 0 and begins counting the elapsed time again. The run will continue until <b>STOP</b> is pressed.</li> <li>• If you switch from <b>HOLD</b> mode to <b>HR:MIN</b> mode during a run, the system remembers the previous time setting. Turning the <b>TIME</b> knob increments or decrements the set time from that point.</li> </ul>
<p><b>TEMPERATURE</b> Knob</p> <p>TEMP °C</p> 	<p>Used to select the rotor temperature, from -10 to +40°C.</p> <ul style="list-style-type: none"> <li>• The minimum and maximum allowable set temperatures depend on the set speed and the rotor in use. If a temperature is entered that cannot be achieved by the installed rotor at the set speed, the <b>TEMP°C</b> field will flash.</li> <li>• The maximum achievable rotor temperature depends on the frictional heat generated inside the chamber during operation. At low run speeds or low ambient temperature, the centrifuge may not be able to achieve some higher temperatures.</li> </ul>
<p><b>ACCELERATION</b> Key</p> <p>MAX SLOW</p> 	<p>Used to select either maximum or slow acceleration. An indicator light above the <b>ACCEL</b> key displays the selection. Acceleration rates are described in <a href="#">Table 3.1</a> (in <a href="#">CHAPTER 3</a>).</p>
<p><b>DECELERATION</b> Key</p> <p>MAX SLOW OFF</p> 	<p>Used to select maximum or slow deceleration, or off (no brake). An indicator light above the <b>DECEL</b> key displays the selection. Deceleration rates are described in <a href="#">Table 3.2</a> (in <a href="#">CHAPTER 3</a>).</p>

## System Keys

<b>START</b>	Pressed to begin a run. When <b>START</b> is pressed, the display immediately shows the actual centrifuge values. The green <b>START</b> light flashes during acceleration until set speed is reached, and then remains on continuously until deceleration begins.
<b>STOP</b>	Pressed to end a run; the centrifuge decelerates to a complete stop according to the deceleration setting. The red <b>STOP</b> light blinks during deceleration. Deceleration can be terminated and the centrifuge restarted by pressing <b>START</b> .
<b>CLEAR</b>	Pressed to stop the flashing of a diagnostic indicator light. See <a href="#">CHAPTER 4, <i>Troubleshooting</i></a> , for information on diagnostic messages.
<b>SET/ACTUAL</b>	Pressed to toggle the display view between set and actual values. The indicator for the selected view will be lit.





## Introduction

---

*This section contains detailed centrifuge operating procedures. A summary is provided on page 3-2. If you are an experienced user of this centrifuge, you can turn to the summary for a quick review of operating steps.*

 **WARNING**

Normal operation may involve the use of solutions and test samples that are pathogenic, toxic, or radioactive. Handle body fluids with care because they can transmit disease. No known test offers complete assurance that they are free of micro-organisms. Some of the most virulent—Hepatitis (B and C) and HIV (I–V) viruses, atypical mycobacteria, and certain systemic fungi—further emphasize the need for aerosol protection. Handle other infectious samples according to good laboratory procedures and methods to prevent spread of disease. Because spills may generate aerosols, observe proper precautions for aerosol containment. Do not run toxic, pathogenic, or radioactive materials in this centrifuge without taking appropriate safety precautions. Biosafe containment should be used when Risk Group II materials (as identified in the World Health Organization *Laboratory Biosafety Manual*) are handled; materials of a higher group require more than one level of protection.

 **WARNING**

Do not use the centrifuge in the vicinity of flammable liquids or vapors, and do not run such materials in the centrifuge. Do not lean on the centrifuge or place items on it while it is operating.

## Summary of Avanti J-26XP Run Procedures

---

*For runs at temperatures other than ambient, precool or prewarm the rotor to the required temperature before the run.*

- 1 Press the **POWER** switch to on (I). Open the centrifuge door.
- 2 Install the rotor. Make sure that the rotor load is balanced and that the rotor is securely fastened to the centrifuge drive hub. Close the centrifuge door.
- 3 Turn the Rotor knob until the installed rotor name appears in the **ROTOR ID** display.
- 4 Turn the **SPEED** knob until the required run speed (rpm) appears in the **SPEED** display. Or press **RPM/RCF** to select **RCF** mode and turn the **SPEED** knob until the required rcf appears in the **SPEED** display.
- 5 Turn the **TIME** knob until the required run length appears in the **TIME** display. Or press **TIME/HOLD** for continuous operation.
- 6 Turn the **TEMP** knob until the required temperature appears in the **TEMP°C** display.
- 7 Press **ACCEL** repeatedly to select **MAX** (maximum) or **SLOW** acceleration.
- 8 Press **DECEL** repeatedly to select **MAX** (maximum) or **SLOW** deceleration, or select **OFF** (no brake).
- 9 Check that all parameters are correct and that the door is closed. Press **START**.
- 10 Wait for the set time to count down to zero, or end the run by pressing **STOP**.
- 11 When the run is complete, open the door and unload the rotor.

## Section and Loading

---

For fast temperature equilibration, precool or prewarm the rotor to the required temperature before the run.

---

- 1 Turn the power switch on (I).
    - Power is applied to the system, and the display illuminates.
  - 2 Step on the foot pedal to open the door.
    - The door opens.
  - 3 Install the rotor according to the instructions in the rotor manual.
    - a. Always run the rotor with a balanced load.
    - b. (If you are using a swinging bucket rotor, fill all positions on the yoke with buckets.
    - c. If you are using a J-Lite® rotor with cannisters, place a cannister in each rotor body cavity.)
- 

 **CAUTION**

**Do not drop the rotor onto the drive hub. The drive shaft can be bent if the rotor is forced sideways or dropped onto the hub. Install the rotor by centering it over the hub and carefully lowering it straight down.**

---

- 4 Securely attach the rotor lid knob, or tie-down knob in rotors without lids, to the drive shaft by turning it to the right (clockwise).

**NOTE** If the knob turns loosely and you do not feel threads engaging, the rotor drive hole pins may not be properly seated on the centrifuge hub. Lift the rotor up above the hub, rotate it slightly, and lower it onto the hub again. Tighten the knob.



- 5 Close the centrifuge door firmly.

 **CAUTION**

**If you leave the rotor in the centrifuge between runs, make sure the rotor is seated on the drive hub and the tie-down knob is tight before each run. (Remove the rotor from the centrifuge if you anticipate a long period between runs.)**

---

## Entering Run Parameters

---

### Selecting a Rotor

- 1 Turn the **ROTOR** knob until the rotor in use appears in the display.
  - Small green LEDs by each rotor type abbreviation light one at a time, and the rotors of that type appear consecutively in the display.

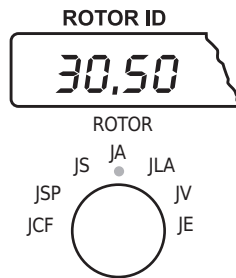

### Setting Run Speed

Enter a run speed up to 26 000 rpm, or up to the maximum speed of the rotor in use. Or, enter a relative centrifugal field (RCF) value up to the maximum achievable RCF of the rotor in use.

### Setting RPM

- 1 Check to see if the red **RPM** light is lit on the display. (**RPM** is the default speed mode.)
  - a. If it is lit, go to step 3.
  - b. If the centrifuge is already in the **RPM** mode, skip step 2 and go on to step 3.
- 2 Press the **RPM/RCF** key to select the **RPM** mode.
  - On the display, the red **RPM** LED lights.



- 3 Turn the **SPEED** knob until the required RPM appears in the **SPEED** display.
    - When the run is started, the centrifuge operates at the set speed.
    - The corresponding RCF is automatically calculated.
- a. Press **RPM/RCF** to display the RCF value.



### Setting RCF

- 1 Check to see if the red **RCF** light is lit on the display.
  - a. If it is lit, go to step 3.
- 2 Press the **RPM/RCF** key to select the **RCF** mode.
  - On the display, the red RCF ( $\times g$ ) LED lights.



- 3 Turn the **SPEED** knob until the required RCF value appears in the **SPEED** display.
    - The centrifuge operates at a speed calculated to produce the set RCF value.
- a. Press **RPM/RCF** to display the **RPM** value.



### Setting Run Time

Pressing the **TIME/HOLD** key toggles the system between **HR:MIN** mode and **HOLD** mode. **HR:MIN** mode is the default.

## Timed Run

---

- 1 Turn the **TIME** knob until the required run time appears in the **TIME** display.
  - If you enter more than 59 minutes in the minutes field, the system automatically converts the entry to hours and minutes after **ENTER** is pressed.

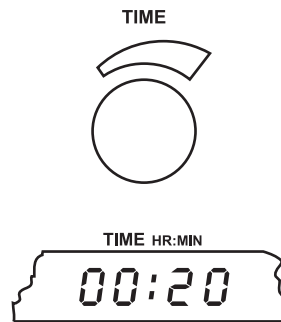

- 2 When all run parameters are entered, press **START**.
    - The rotor begins to accelerate and the display begins showing the remaining run time.
    - The run will end when the time counts down to 0 or when **STOP** is pressed.
- 

## Continuous (HOLD) Run

---

- 1 Press the **TIME/HOLD** key to select the **HOLD** mode.
  - The red **HOLD** indicator light comes on in the **TIME** display.



- 2 When all run parameters are entered, press **START**.
    - The rotor begins to accelerate and the display begins showing the elapsed time.
    - The time will count up to 3 hours, 0 minutes, and then will reset to 0 and continue counting.
  - 3 Press **STOP** to end the run.
    - The rotor decelerates to a stop.
-

## Setting Run Temperature

Select a run temperature between  $-10$  and  $+40^{\circ}\text{C}$ , in  $1^{\circ}\text{C}$  increments.

**NOTE** For runs at temperatures other than ambient, always refrigerate or warm the rotor to the required run temperature before the run. For low-temperature runs, precool the system by running a precooled rotor at 2000 rpm at the required temperature for at least 30 minutes.

**1** Turn the **TEMP $^{\circ}\text{C}$**  knob until the required temperature appears in the display.

- After you release the knob, the display shows the selected temperature.
- After 5 seconds, the display reverts to the actual current chamber temperature.
- When the run begins, the display shows the rotor temperature  $\pm 2^{\circ}\text{C}$  (after a period of temperature equilibration).

**NOTE** The system controls the chamber temperature to within  $\pm 2^{\circ}\text{C}$  of the set temperature.\* To control temperature within  $\pm 1^{\circ}\text{C}$  of set, perform the temperature calibration procedure provided in the Appendix.

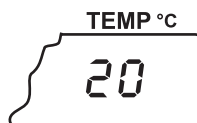

## Setting Acceleration and Deceleration Rates

Table 3.1 and Table 3.2 describe the acceleration and deceleration settings. Figure 3.1 provides a graphic representation of these settings.

**Table 3.1** Acceleration Settings

Maximum Acceleration (not available with the JS-24.38 and JS-24.15 rotors)	Slow Acceleration
Full torque is used from 0 rpm until set speed is reached	Reduced torque is used from 0 to 500 rpm, lasting approximately 2 minutes. (The time varies depending on the mass of the rotor in use. Larger rotors take longer.) Above 500 rpm, full torque is used until set speed is reached.
Application: pelleting	Application: gradients

\* During transient conditions, such as acceleration and deceleration, rotor temperature may be outside this range.

**Table 3.2** Deceleration Settings

Maximum Deceleration	Slow Deceleration	Off
Full brake is used from set speed to near 0 rpm, to bring the rotor to a stop in the shortest possible time. Reduced brake is used during the last few rpm until 0 is reached, to minimize disturbance of the sample.	Reduced torque is used from set speed to 500 rpm, causing deceleration to 500 rpm to take twice as long as maximum deceleration. (The exact rate depends on the mass of the rotor in use. Larger rotors will take longer.) Deceleration time from 500 to 0 rpm is approximately 2 minutes (larger rotors take longer).	No brake is used. Rotor coasts to 0 rpm. This process can take up to 1 hour, depending on the rotor in use and the speed at the start of deceleration.
Application: pelleting	Application: gradients, pelleting	Application: gradients

**Figure 3.1** Acceleration and Deceleration Settings Graph

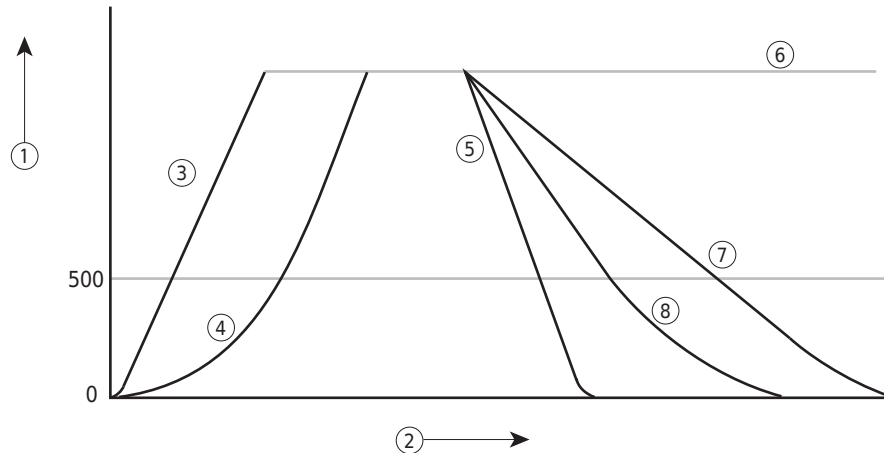

- |                      |                   |
|----------------------|-------------------|
| 1. Rotor Speed (RPM) | 5. Max Decel      |
| 2. Time              | 6. Run Speed      |
| 3. Max Accel         | 7. Off (no brake) |
| 4. Slow Accel        | 8. Slow Decel     |

### Setting the Acceleration Rate

**NOTE** The default setting for both acceleration and deceleration is maximum (**MAX**). If the **MAX** indicator lights are already lit, no input is required. To choose a different setting, follow the steps below.



- 1 Press the **ACCEL** key to toggle between the **MAX** and **SLOW** acceleration settings.
  - The selected setting lights.



### Setting the Deceleration Rate

- 1 Press the **DECEL** key to toggle between the **MAX**, **SLOW**, and **OFF** deceleration settings.
  - The selected setting lights.



### Setting Up an Elutriation Run

Centrifuges equipped for elutriation have elutriation controls as shown in [Figure 3.2](#), along with a view port in the door and an elutriation power box mounted on the back of the control panel. See the JE-5.0 elutriator rotor manual (JE5-IM) for complete rotor setup and operating instructions.

**Figure 3.2** Elutriation Controls

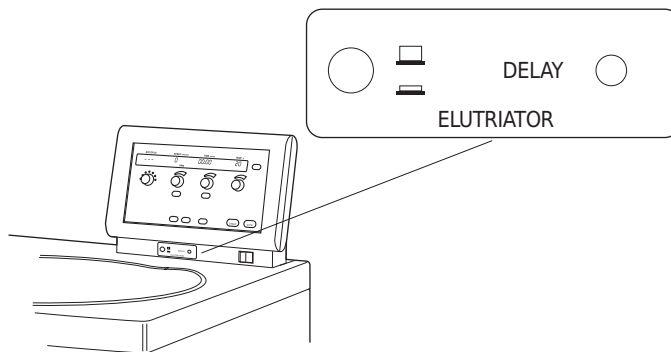

- 1 Install the rotor.
- 2 Set up sample and buffer reservoirs and tubing lines as described in the rotor manual.
  - a. Route the tubing lines through the elutriator port holes at the left side of the door seal.
  - b. Close the centrifuge door.
- 3 Turn the **ROTOR** knob to the **JE** position.
  - 5.0 appears in the **ROTOR ID** display.

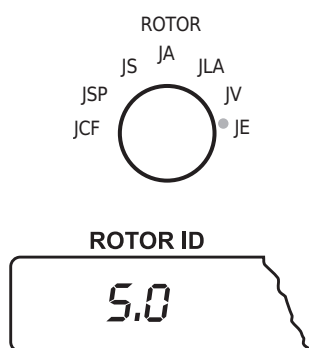

- 4 Enter the remaining run parameters. Refer to the JE-5.0 rotor manual for rotor setup and operating instructions.
  - The run is ready to begin.
- 5 Press **START**.
  - The rotor accelerates to set speed.
- 6 When the rotor reaches set speed, turn on the strobe controls by pressing the strobe power switch.
  - The power switch indicator lights.

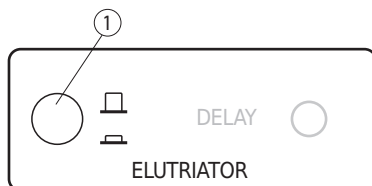

1. Strobe Power Switch

- 7 When the rotor speed has stabilized, look through the port in the centrifuge door and turn the **DELAY** knob until the elutriation chamber in the rotor is synchronized with the strobe.
  - (The chamber will appear to be motionless.)
  - Sample can now be injected into the lines.
  - See the rotor instruction manual for detailed instructions.

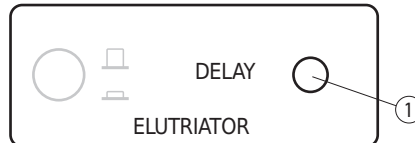

1. Delay Control Knob

**NOTE** At the end of the run, after disassembling the liquid and power lines, be sure to replace the black rubber stoppers in the ports at the left side of the centrifuge door. Failure to seal these openings will prevent proper operation of the FRS system, which will cause a diagnostic shut down during the next run.

## Starting a Run

- 1 Check that all parameters are correct and the door is firmly closed.
- 2 Press **START**.
  - The display will start showing actual centrifuge values within 5 seconds.
  - The LED on the **START** key flashes during acceleration.
  - When set speed is reached, the light stays on continuously until the centrifuge begins decelerating.
  - As the run begins, the system identifies the installed rotor.
  - The system verifies that the user-selected rotor and the installed rotor are the same.
  - If the system detects that the installed rotor is not the rotor that the user selected with the **ROTOR** knob, and the speed selected by the user is *greater* than the installed rotor's maximum permitted speed, the system will reduce the run speed to the maximum allowed for the installed rotor.

## Changing Parameters During a Run

---

While a run is in progress, the speed, time, temperature, and acceleration or deceleration setting can be changed without stopping the run. The rotor name parameter cannot be changed during a run:

### Changing Time Settings

---

- 1** To increase or decrease the remaining run time, turn the knob to the new run time.
    - The system will add the new remaining time to (or subtract from) the time already elapsed, and the display will show the new remaining run time.
    - If you turn the **TIME** knob to a value less than the length of time the centrifuge has already been running, the run will end and the rotor will begin to decelerate immediately. For example, if the centrifuge has been running for 20 minutes and you turn the knob until **10** shows in the display, the run will end.
  - 2** To set a completely new run time while a timed run is in progress, turn the **TIME** knob to the new time setting and press **START**.
    - The system will ignore any elapsed time.
  - 3** To change from **HR:MIN** mode to **HOLD** mode, press the **TIME/HOLD** key.
    - The display will show the total accumulated run time and will begin counting the time elapsed from that point.
  - 4** To change from **HOLD** mode to **HR:MIN** mode, press the **TIME/HOLD** key and turn the **TIME** knob until the run length appears in the display.
    - a.** Press **START**.
      - The system will ignore any elapsed time and will begin displaying the time remaining in the run.
- 

### Stopping a Run

---

A timed run ends automatically when the **TIME** display counts down to zero. “**End**” will flash in the **TIME** display. To end a **HOLD** run or a run in progress for any reason, press **STOP**.

**NOTE** If a diagnostic condition causes the run to stop, with or without use of the brake, the appropriate diagnostic message will light and the light on the **STOP** key will flash until the rotor comes to a complete stop.

- 
- 1 Press **STOP** to initiate deceleration.
    - The light on the **STOP** key flashes until the rotor comes to a stop.

- 
- 2 After the rotor stops spinning, step on the foot pedal to open the door.

**NOTE** During runs at very cold temperatures, nominally  $-10^{\circ}\text{C}$  or below, ice may form around the door opening, causing the door to stick shut. If this happens, press firmly on the door in several locations around the door opening and depress the foot pedal again.

To minimize icing, remove moisture from inside the chamber, from the chamber gasket, and from the inner door surface before each run by wiping these surfaces with a clean cloth. Also, keep the door closed as much as possible.



---

## Unloading the Centrifuge

---

At the end of a run, unload the rotor following the instructions in the applicable rotor manual.

 **CAUTION**

**If disassembly reveals evidence of leakage, you should assume that some fluid escaped the rotor. apply appropriate decontamination procedures to the centrifuge and accessories as required.**



# Troubleshooting

## Introduction

---

This chapter lists possible malfunctions, along with probable causes and corrective actions. Maintenance procedures are given in [CHAPTER 5, Care and Maintenance](#). For any problems not covered here, contact Beckman Coulter Field Service (1-800-742-2345 in the United States for assistance).

**NOTE** It is your responsibility to decontaminate the instrument, as well as any rotors and/or accessories, before requesting service by Beckman Coulter Field Service.

## User Messages

---

FRS	SYS
ROTOR	POWER
IMBAL	DRIVE
SPEED	REFR
DOOR	TEMP



If a problem occurs during operation, the appropriate diagnostic message will light and a beep will sound to alert you to the condition. See [Table 4.1](#) for a list of the diagnostic messages, the probable causes, and the recommended actions.

Two kinds of diagnostic conditions can occur.

- *Cautionary diagnostic messages* alert you to a condition that may need attention when the run is complete. Cautionary diagnostic messages provide information only; they do not shut down the run in progress. Press **CLEAR** to stop the light from flashing. If the condition still exists, the diagnostic message will begin flashing again, even though the run continues.
- *Shutdown diagnostic messages* occur when a problem exists that prevents the run from continuing. The diagnostic message will flash and the red **STOP** key light will also flash, indicating that the rotor is decelerating to a stop. You can press **CLEAR** to stop the diagnostic message from flashing. However, if the diagnostic condition still exists (for example, if the rotor is out of balance), another beep will sound and the message will start flashing again.

Table 4.1 contains information on causes and recommended actions for each diagnostic condition. If you are unable to correct the problem, call Beckman Coulter Field Service (in the United States, call 1-800-742-2345; outside of the U.S., call your local Beckman Coulter office). To help the Field Service representative diagnose and correct the problem, provide as much information about the situation as you can, including:

- the diagnostic message,
- the operating situation when the diagnostic condition occurred (such as, rotor in use, speed, or load type), and
- any unusual environmental and/or operating conditions (such as ambient temperature, or voltage fluctuations).

**NOTE** The information in Table 4-1 is provided as a user guide, and is not a comprehensive checklist.

**Table 4.1** Diagnostic Message Chart

Diagnostic Message	Problem	Result	Recommendation
<b>FRS</b> (friction reduction system)	FRS integrity is not established within 10 seconds after the pump is turned on	Run shuts down with maximum brake	<ul style="list-style-type: none"> <li>• Check and clean door sealing area and door gasket.</li> <li>• Wipe excess moisture from chamber.</li> <li>• Make sure that elutriator port stoppers are in place at left side of door seal.</li> </ul>
	Required FRS level not reached within 90 seconds	Run shuts down with maximum brake	Call Beckman Coulter Field Service. <sup>a</sup>
	FRS level stays too high for 45 seconds	Run continues	Press <b>CLEAR</b> to stop LED from flashing.
	FRS level stays too high for 60 seconds	Run shuts down with maximum brake	Call Beckman Coulter Field Service. <sup>a</sup>
<b>IMBAL</b> (imbalance)	Rotor load is imbalanced	Run shuts down with maximum brake	<ul style="list-style-type: none"> <li>• Make sure that the tubes are loaded symmetrically in the rotor.</li> <li>• With swinging bucket rotors, lubricate the buckets according to the rotor manual instructions. Unlubricated pivot pins can prevent the buckets from reaching horizontal position, which can cause imbalance.</li> </ul>



**Table 4.1** Diagnostic Message Chart (Continued)

Diagnostic Message	Problem	Result	Recommendation
<b>ROTOR</b>	System-identified rotor does not match user-set rotor; set speed above rotor maximum	System lowers run speed to the maximum of the rotor identified by system	Press <b>CLEAR</b> to stop LED from flashing.
	System cannot identify rotor (rotor ID system malfunction)	Run shuts down with maximum brake	Check rotor and restart run.
	No rotor in chamber	Run starts; within seconds the system determines that no rotor is installed and the run shuts down with maximum brake	Install rotor and restart run.
<b>SPEED</b>	Speed control system is malfunctioning	Rotor spinning above set speed; run shuts down with maximum brake	Call Beckman Coulter Field Service. <sup>a</sup>
<b>DOOR</b>	Door is not latched properly or interlock is out of position	<b>DOOR</b> LED lights after <b>START</b> is pressed and system shuts down	Open the door and close it firmly; press <b>CLEAR</b> to stop LED from flashing. Restart the run.
	Door stays locked after rotor stops spinning	Sample cannot be retrieved	Restart the centrifuge and perform a brief run. If door will still not open after deceleration, call Beckman Coulter Field Service.
	Door latches do not close and lock	Run cannot start	Check the latch hole (at left of door) for debris. Gently clean the area with a lintless cloth or tissue. Be careful not to damage sensitive electronics in the area.
<b>SYS</b> (system)	There is a problem with the system control software, EPROM, or RAM	System shuts down	Call Beckman Coulter Field Service.

**Table 4.1** Diagnostic Message Chart (*Continued*)

Diagnostic Message	Problem	Result	Recommendation
<b>POWER</b>	Momentary power failure; rotor does not come to a complete stop	Run continues when power resumes; elapsed time continues counting from current value	Press <b>CLEAR</b> to stop LED from flashing.
	Power failure; rotor comes to a complete stop	Run restarts when power resumes; elapsed time starts counting from 0	Press <b>CLEAR</b> to stop LED from flashing.
<b>DRIVE</b>	Drive system malfunctioning (for example, over current, over/under voltage, components over temperature)	Run stops, usually with no brake. Door may not unlock for up to an hour.	Call Beckman Coulter Field Service. Before trying to open the door, listen carefully and make sure that no sound is coming from the chamber (indicating a spinning rotor). Follow the directions under <a href="#">Accessing the Rotor in Case of Power Failure</a> , below.
<b>REFR</b> (refrigeration system)	Refrigeration system malfunctioning	Run shuts down with maximum brake	Call Beckman Coulter Field Service.
<b>TEMP</b>	The refrigeration system is not cooling and the chamber temperature has exceeded 50°C.	Run shuts down with maximum brake	Call Beckman Coulter Field Service.
—	During low-temperature runs (near -10°C), ice forms around the door opening	Door will not open at the end of a run	Press firmly in several locations around the door opening, then depress the foot pedal again.  To minimize icing, wipe moisture from the chamber, the chamber gasket and the inner door surface before each run. Keep the door closed as much as possible.

a. In the United States, call 1-800-742-2345. Outside the U.S., contact your local Beckman Coulter office.

## Accessing the Rotor in Case of Power Failure

**WARNING**

Any maintenance procedure requiring removal of a panel exposes the operator to the possibility of electrical shock and/or mechanical injury. therefore, turn the power off (0) and disconnect the instrument from the main power source, and refer such maintenance to qualified service personnel.

**WARNING**

Before performing this procedure, verify that the rotor is not spinning by listening carefully for any noise coming from the chamber. Proceed only if the instrument is quiet. Never attempt to override the door interlock system while the rotor is spinning.

If the facility power fails only momentarily, the centrifuge will resume operation when the power is restored and the rotor will return to the set speed. In the event of an extended power failure, it may be necessary to override the door-locking mechanism manually to remove the rotor and retrieve your sample.

To access the door-locking mechanism, you must remove the centrifuge front panel. Two latches secure the front panel in place; these latches are accessible through two holes at the upper right and left of the panel (see Figure 4.1).

**Figure 4.1** Emergency Door Release Latch Access

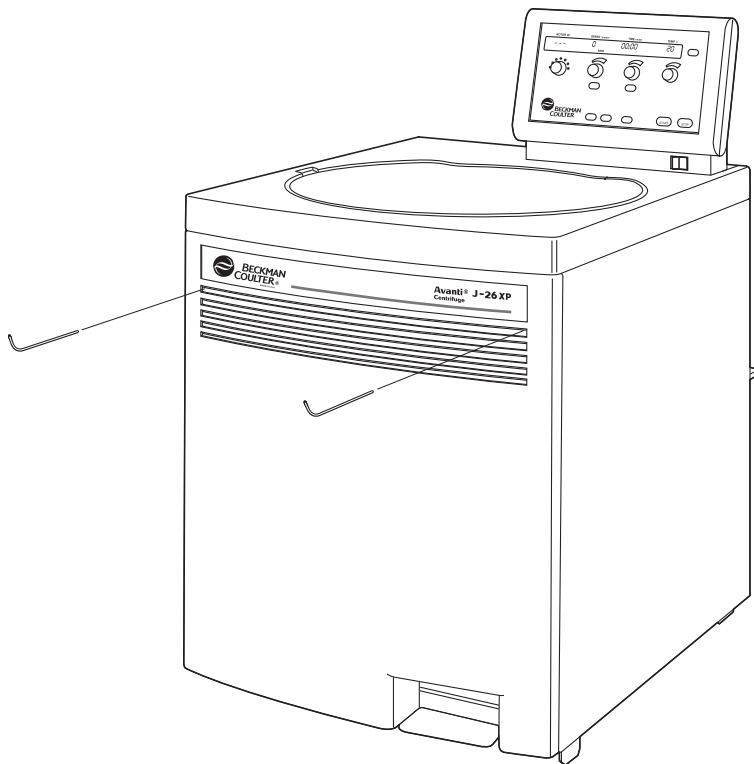

- 1 Turn the power switch to off (O) and unplug the power cord from the main source.
- 2 Insert a 4-mm or  $\frac{5}{32}$ -in. Allen wrench straight through one of the holes (either one) and turn the wrench to the left (counterclockwise) about one-half turn.
  - The latch disengages.
- 3 Repeat step 2, inserting the Allen wrench through the other hole.
  - After the second latch disengages, the front panel will fall forward about an inch from the top.
  - The bottom of the front panel is held in place by three grooved brackets, attached to the front panel, that seat over a metal retaining strip on the centrifuge bottom panel.
- 4 Lift the front panel up and off the centrifuge; set it aside.
  - You will see an inner front panel that extends about halfway down from the centrifuge top (see [Figure 4.2](#)).
  - Below this inner panel is a black manual door release interlock lever (see [Figure 4.2](#)).

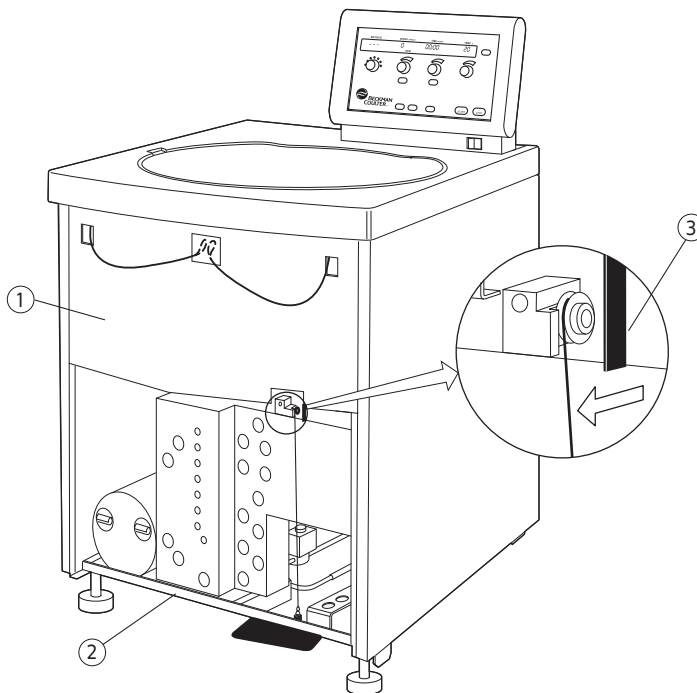
**Figure 4.2** Manual Door Release

1. Inner Front Panel
2. Retaining Strip
3. Manual Door Release Interlock Lever

- 
- 5** Pull the interlock lever out and to the left (at about a 45-degree angle), and while holding it out, step on the foot pedal.
- Depending on the level of vacuum in the chamber at the time of the power failure, the door may or may not open.
- a. If it opens, go to step 6.
  - b. If it does not open, you will need to manually vent the vacuum. Go to step 7.
- 

- 6** After the door opens, first release the foot pedal and then release the interlock lever.
- Sample can be removed.
- a. Go to step 10.
- 

- 7** To vent the chamber vacuum, grasp the red rubber hose and pull it up until it comes off of the pump fitting (see [Figure 4.3](#)).
- a. Use a back-and-forth motion as you pull; this takes quite a bit of force.
    - The vacuum will be completely vented several seconds after the hose is detached.
- NOTE** Several tubing lines are tied to the red hose. As you grasp the hose, place your hand over these lines. Make sure that they stay connected as you pull.
- 

 **CAUTION**

**Do not twist the hose to the left (counterclockwise) as you pull the hose, or your will unscrew the hose fitting.**

---

- 8** Replace the hose by pushing it down over the fitting as far as it can go.
- 
- 9** Pull the interlock level out and left, and while holding it out, step on the foot pedal.
- 

- 10** Remove your sample.

 **WARNING**

**Never try to slow or stop the rotor by hand.**

---

**Figure 4.3** Venting the Chamber Vacuum

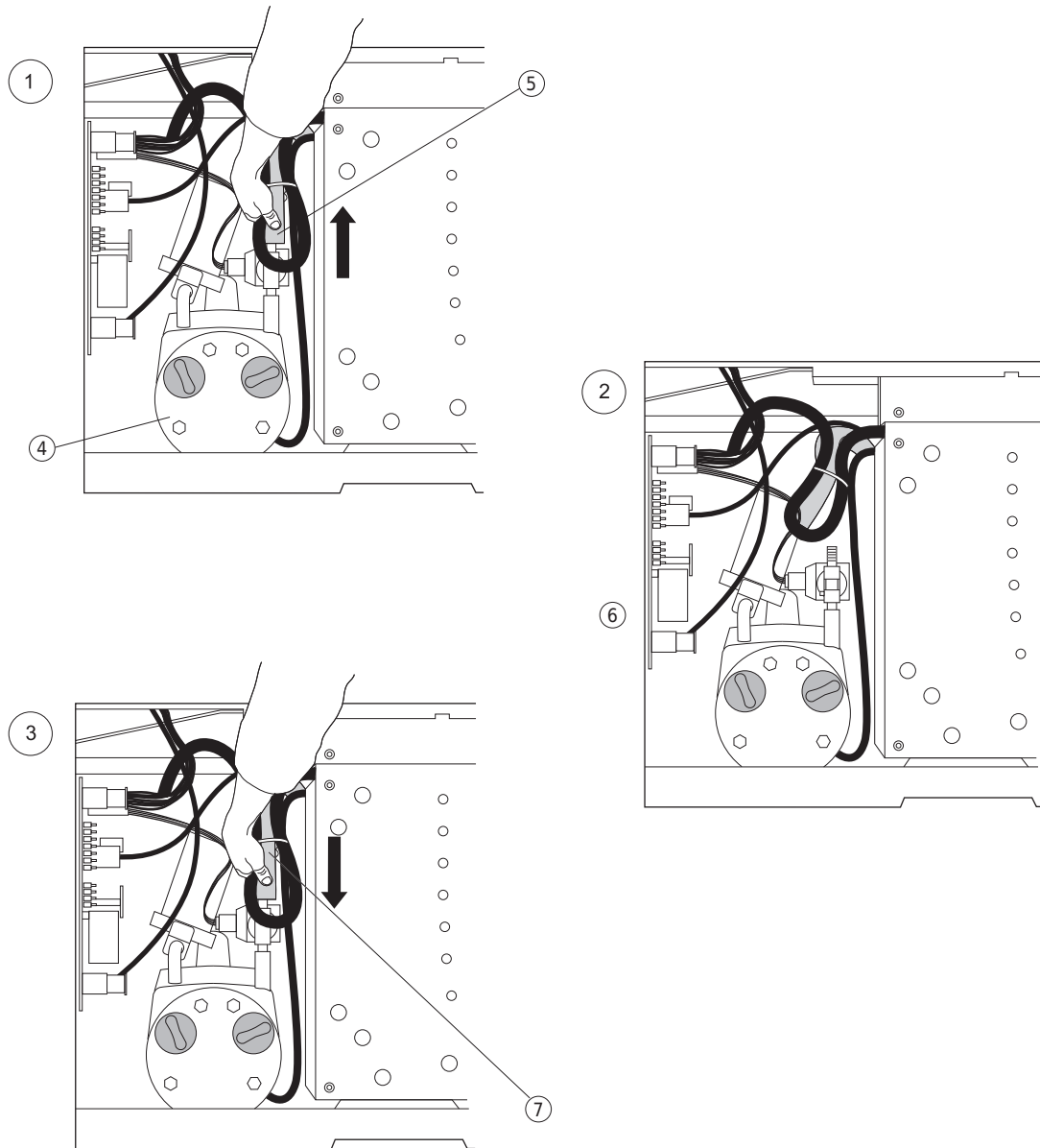

- |   |  |
|---|--|
| <ol style="list-style-type: none"> <li>1. Step 1</li> <li>2. Step 2</li> <li>3. Step 3</li> <li>4. Vacuum Pump</li> </ol> | <ol style="list-style-type: none"> <li>5. Grasp red hose and pull up Do <i>not</i> disconnect the tubing lines tied to the red hose.</li> <li>6. Red hose removed from fitting</li> <li>7. Replace red hose</li> </ol> |
|---|--|

To replace the panel on the centrifuge,

- 1 Holding the panel at the top (with the instrument label facing out), insert the three grooved brackets on the bottom inside of the door over the front panel retaining strip (see [Figure 4.4](#)).
  - a. Push the top of the front panel into place.

- 2 Hold the left top edge in place and insert the Allen wrench through the hole.
    - a. Turn to the right (clockwise) about one-half turn, until you reach a stop.
      - The latch engages.
- 
- 3 Repeat step 2 on the right side
    - The second latch engages.
- 

**Figure 4.4** Front Panel Retaining Strip

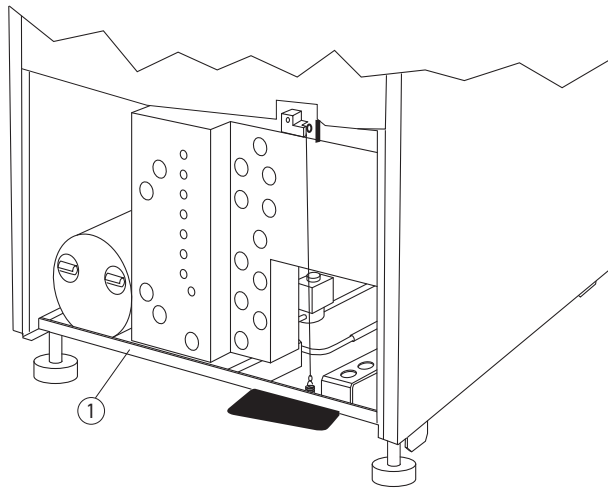

1. Retaining Strip
- 

## JCF-Z Rotor Identification

---

The rotor identification system can, under two specific conditions, misidentify the JCF-Z continuous flow/zonal rotor. Misidentification has occurred if a rotor name other than JCF-Z appears in the **ROTOR** display during the run, when rotor identification is complete. If the rotor is misidentified, stop the run and follow one of the steps below.

**NOTE** Misidentification can be prevented by returning your JCF-Z rotor to the Beckman Coulter factory to have magnets added to the rotor body. The magnets ensure correct identification. Call your local Beckman Coulter Field Service representative\* for more information.

JCF-Z rotors manufactured after March, 1997, have factory-installed magnets.

---

\* In the United States, call 1-800-742-2345. Outside the U.S., contact your local Beckman Coulter office.

- 
- 1** *On the first few uses of a new JCF-Z rotor, or in an older JCF-Z rotor with newly replaced bearings, run the rotor from 0 to 5000 rpm and back to 0 rpm three times.*
- This procedure will distribute lubricant around the bearings in the rotating seal assembly, reducing drag.

- 
- 2** *In older JCF-Z rotors with bearings that have not been replaced recently, follow the same procedure as for a new JCF-Z rotor (perform three runs from 0 to 5000 rpm and back to 0 rpm) to ensure that the bearings are properly lubricated.*
- If misidentification recurs after the third run, when the bearings are lubricated, this indicates that the bearings are worn and need to be replaced.
- a.** Replace the bearings following the instructions in the JCF-Z manual (JCFZ-IM).

**NOTE** If the JCF-Z rotor is misidentified, the run speed will be limited to the maximum speed for the identified rotor. (The maximum speed for the JCF-Z rotor is 20 000 rpm.)

---



# Care and Maintenance

## Introduction

---

*This section describes routine care and maintenance procedures that you should perform regularly or as required. For maintenance not covered in this manual, contact Beckman Field Service.\* Refer to the applicable rotor manual and Rotors and Tubes for J Series Centrifuges (publication JR-IM) for instructions on the care of rotors and accessories.*

**NOTE** It is your responsibility to decontaminate the instrument, as well as any rotors and/or accessories, before requesting service by Beckman Coulter Field Service.

 **WARNING**

**Any maintenance procedure or servicing of this equipment that requires removal of any covers can expose parts which involve the risk of electric shock or personal injury. Make sure that the power switch is off (O) and the centrifuge is disconnected from the main power source, and refer such servicing to qualified service personnel.**

 **WARNING**

**Do not use alcohol or other flammable substances in or near operating centrifuges.**

## Maintenance

---

Perform the following procedures regularly to ensure continued performance and long service life of the centrifuge.

- 1** Inspect the centrifuge chamber for accumulations of sample, dust, or glass particles from broken sample tubes.
  - a.** Clean as required (see [Cleaning](#) below).

---

\* In the United States, call 1-800-742-2345. Outside the U.S., contact your local Beckman Coulter office.

- 
- 2 Check the air filter on the back panel for obstructions.
    - a. Keep vents clear and clean.
- 
- 3 Wipe condensation out of the chamber between runs with a sponge or clean cloth to prevent chamber icing.
- 
- 4 If chamber icing occurs, defrost the system and wipe moisture out of the chamber before use.
    - a. To defrost the system, set the temperature to 30°C for 20 minutes.
      - (These are suggested settings that may be adjusted as appropriate for your laboratory conditions.)
- NOTE** Before using any cleaning or decontamination methods except those recommended by the manufacturer, users should check with the manufacturer that the proposed method will not damage the equipment.
- 

## Cleaning

Clean the centrifuge frequently. Always clean up spills when they occur to prevent corrosives or contaminants from drying on component surfaces.

- 
- 1 To prevent accumulations of sample, dust, and/or glass particles from broken sample tubes, keep the chamber clean and dry by frequent wiping with a cloth or paper towel.
    - a. For thorough cleaning, wash the chamber using a mild detergent such as Beckman Solution 555™, diluted 10 to 1 with water.
    - b. Rinse thoroughly and dry completely.
- 
- 2 Clean the centrifuge exterior surfaces by wiping with a cloth dampened with Solution 555, diluted 10 to 1 with water.
    - a. Do not use acetone.
- 
- 3 Clean the drive hub regularly using Solution 555 (diluted 10 to 1 with water) and a soft brush.
    - a. Rinse thoroughly and dry completely.
- 

## Tube Breakage

If a glass tube breaks, and all the glass is not contained in the bucket or rotor, be sure to thoroughly clean the chamber.

**WARNING**

Be careful when examining or cleaning the chamber and chamber gasket, as sharp glass fragments may be embedded in their surfaces.

- 1 Examine the chamber gasket to make sure that no glass particles are retained in it.
  - a. Carefully remove any glass particles that may remain.
- 2 Carefully wipe away any glass particles that remain in the chamber.

## Decontamination



If the instrument and/or accessories are contaminated with radioactive or pathogenic solutions, perform all appropriate safety and decontamination procedures. Refer to Appendix A in *Rotors and Tubes* or publication IN-175 to be sure the decontamination method will not damage any part of the instrument

## Sterilization and Disinfection

The centrifuge is finished with acrylic baking enamel on most surfaces (see [CHAPTER 1, Specifications](#)). Ethanol (70%)\* may be used on this surface. See Appendix A in *Rotors and Tubes* or publication IN-175 for chemical resistances of centrifuge and accessory materials.

While Beckman Coulter has tested ethanol (70%) and found that it does not damage the centrifuge, no guarantee of sterility or disinfection is expressed or implied. When sterilization or disinfection is a concern, consult your laboratory safety officer regarding proper methods to use.

---

\* Flammability hazard. Do not use in or near operating centrifuges.

## Replacing the Air Filter

- 1 Check the air filter regularly and replace it about once a year, or more often if it looks dirty.
  - The air filter is not fastened to the centrifuge, so no tools are required for removal or installation.

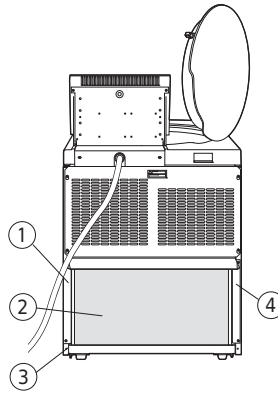

- |               |                    |
|---------------|--------------------|
| 1. Frame Edge | 3. Retaining Strip |
| 2. Air Filter | 4. Frame Edge      |

- 2 To remove the air filter, hold the side edges and lift the filter straight up until the bottom edge is above the centrifuge bottom retaining strip.
  - a. Pull the filter out, bottom edge first, and discard it.
- 3 Install a new filter (885218).
  - a. The filter has a directional arrow on one of its edges; install the filter with this arrow pointing toward the centrifuge.
  - b. Holding the filter by the side edges, insert the top half behind the frame edge and lift up until the bottom half clears the retaining strip.
  - c. Then set the bottom edge down.

## Circuit Breaker and Fuses

---



There are no user-replaceable fuses in the Avanti J-26XP centrifuge.

If the centrifuge circuit breaker trips for any reason, the power switch will move to the OFF (O) position. Reset the circuit breaker by turning the power switch back to the ON (I) position. If it trips again immediately, do not reset it. Call Beckman Coulter Field Service.



**Repeated attempts to reset the centrifuge circuit breaker can cause substantial damage to electrical and electronic components.**

## Storage and Transport

---

### Storage

To ensure that the centrifuge does not get damaged, contact Beckman Coulter Field Service for specific instructions and/or assistance in preparing the equipment for transport or long-term storage. Temperature and humidity conditions for storage should meet the environmental requirements described under *Specifications* in [CHAPTER 1](#).

### Returning a Centrifuge

Before returning a centrifuge or accessory for any reason, prior permission (a Returned Goods Authorization form) must be obtained from Beckman Coulter, Inc. Contact your local Beckman Coulter office to obtain the RGA form and instructions for packaging and shipping.

To protect our personnel, it is the customer's responsibility to ensure that all parts are free from pathogens and/or radioactivity. Sterilization and decontamination must be done before returning the parts.

*All parts must be accompanied by a note, plainly visible on the outside of the box or bag, stating that they are safe to handle and that they are not contaminated with pathogens or radioactivity. Failure to attach this notification will result in return or disposal of the items without review of the reported problem.*

## Supply List

Refer to the *High Performance, High Speed, High Capacity Rotors, Tubes & Accessories catalog* (BR-8102, available at [www.beckmancoulter.com](http://www.beckmancoulter.com)) and the applicable rotor manual for materials and supplies needed for rotors. For your convenience, a partial list of centrifuge supplies is given below.

### Replacement Parts and Supplies

Description	Part Number
Air filter	885218
Beckman Solution 555™ (1 qt)	339555
Zonal Bracket Kit for Cole-Parmer size 16 tubing (6.4-mm [ <sup>1</sup> / <sub>4</sub> -in.] O.D.)	366431
Zonal Bracket (qty 1)	366430
Thumbscrew, stainless steel, M4 (threads) x 19 mm (qty 2)	893412
Thumbscrew, stainless steel, M4 (threads) x 12 mm (qty 2)	893411
Cable Clamp, nylon, 6.4-mm ( <sup>1</sup> / <sub>4</sub> -in.) I.D. (qty 10)	000499
Zonal Tubing Adapter for Cole-Parmer size 14 tubing (4.8-mm [ <sup>3</sup> / <sub>16</sub> -in.] O.D.)	363844
<b>Note:</b> kit 366431 is also required.	
Tubing Adapter, stainless steel, for size 14 tubing (qty 2)	363830
Cable Clamp, nylon, 4.8-mm ( <sup>3</sup> / <sub>16</sub> -in.) I.D. (qty 10)	003343
Zonal Tubing Adapter for Cole-Parmer size 15 tubing (9.6-mm [ <sup>3</sup> / <sub>8</sub> -in.] O.D.)	363845
<b>Note:</b> kit 366431 is also required.	
Tubing Adapter, stainless steel, for size 15 tubing (qty 2)	363831
Cable Clamp, nylon, 9.6-mm ( <sup>3</sup> / <sub>8</sub> -in.) I.D. (qty 10)	000596
Elutriation upgrade kit	366562

# Temperature Calibration Procedure

## Introduction

---

The Avanti J-26 XP centrifuge specification for temperature control is  $\pm 2^{\circ}\text{C}$  of the set temperature. That means that your sample will stay within  $2^{\circ}\text{C}$  of set temperature at all times, after rotor and system equilibration, described below. (During transient conditions, such as acceleration and deceleration, the rotor temperature may be outside this range.) The following procedure is provided for those cases in which temperature control within  $\pm 1^{\circ}\text{C}$  is required.

In this procedure, you will measure the temperature of your sample after equilibrating the rotor temperature for a minimum of 1 hour. Based on the test results, you can then adjust the centrifuge temperature setting to bring your sample as close as possible to the required temperature.

- 
- 1** For runs at other than ambient temperature, precool or prewarm the rotor and test samples to the required temperature.
    - The length of precooling/prewarming time depends on how different the rotor starting temperature is from the required run temperature.

---

  - 2** Install the rotor with adapters, if applicable, and tubes or bottles filled with sample buffer or water (if above  $2^{\circ}\text{C}$ ).

---

  - 3** Set the speed to 2000 rpm, the time to **HOLD**, and the temperature to the required run temperature.
    - a.** Start the run.

---

  - 4** After 30 minutes, set the required run speed, and allow the system to run for at least 1 hour.

**NOTE** *The system must run for at least 1 hour before the temperature of the buffer or water is measured. The length of time required for equilibration depends on the rotor and centrifuge starting temperatures and the ambient room temperature.*

---

  - 5** After at least 1 hour, measure the temperature of the buffer or water using a thermometer or thermocouple.

- 
- 6** If the measured and set temperatures are different, note how many degrees different they are and adjust the set temperature up or down that number of degrees.
- 

For example:

If the required sample temperature is	And the measured buffer/ water temperature is	Set the temperature to
4°C	6°	2°
5°	4°	6°



# Beckman Coulter, Inc.

## Avanti<sup>®</sup> J Series Centrifuge Warranty

Subject to the exceptions and upon the conditions specified below Beckman Coulter, Inc. agrees to correct either by repair, or, at its election, by replacement, any defects of material or workmanship which develop within one (1) year (3 years for the drive motor) after delivery of the Avanti<sup>®</sup> J Series Centrifuge (the product), to the original buyer by Beckman Coulter or by an authorized representative, provided that investigation and factory inspection by Beckman Coulter discloses that such defect developed under normal and proper use.

Some components and accessories by their nature are not intended to and will not function for as long as one (1) year. If any such component or accessory fails to give reasonable service for a reasonable period of time, Beckman Coulter will repair or, at its election, replace such component or accessory. What constitutes either reasonable service and a reasonable period of time shall be determined solely by Beckman Coulter.

### **Replacement**

Any product claimed to be defective must, if requested by Beckman Coulter, be returned to the factory, transportation charges prepaid, and will be returned to Buyer with the transportation charges collect unless the product is found to be defective, in which case Beckman Coulter will pay all transportation charges.

Beckman Coulter makes no warranty concerning products or accessories not manufactured by it. In the event of failure of any such product or accessory, Beckman Coulter will give reasonable assistance to the Buyer in obtaining from the respective manufacturer whatever adjustment is reasonable in light of the manufacturer's own warranty.

### **Conditions**

Beckman Coulter shall be released from all obligations under all warranties, either expressed or implied, if the product covered hereby is repaired or modified by persons other than its own authorized service personnel, unless such repair by others is made with the written consent of Beckman Coulter, or unless such repair in the sole opinion of Beckman Coulter is minor, or unless such modifications is merely the installation of a new Beckman Coulter plug-in component for such product.

### **Disclaimer**

IT IS EXPRESSLY AGREED THAT THE ABOVE WARRANTY SHALL BE IN LIEU OF ALL WARRANTIES OF FITNESS AND OF THE WARRANTY OF MERCHANTABILITY AND THAT BECKMAN COULTER, INC. SHALL HAVE NO LIABILITY FOR SPECIAL OR CONSEQUENTIAL DAMAGES OF ANY KIND WHATSOEVER ARISING OUT OF THE MANUFACTURE, USE, SALE, HANDLING, REPAIR, MAINTENANCE, OR REPLACEMENT OF THE PRODUCT.



Symbol Symbol Symbole Símbolo	Simbolo 記号 符号 Title / Titel / Titre / Titolo / Titolo / 名称 / 名称
	Dangerous voltage Gefährliche elektrische Spannung Courant haute tension Voltaje peligroso Pericolo: alta tensione <b>危険電圧</b> <b>危险电压</b>
	Attention, consult accompanying documents Achtung! Begleitpapiere beachten! Attention, consulter les documents joints Atención, consulte los documentos adjuntos Attenzione: consultare le informazioni allegate <b>注意、添付資料を参照のこと</b> <b>注意，请参阅附带的文件</b>
	On (power) Ein (Netzverbindung) Marche (mise sous tension) Encendido Acceso (sotto tensione) <b>入（電源）</b> <b>开（电源）</b>
	Off (power) Aus (Netzverbindung) Arrêt (mise hors tension) Apagado Spento (fuori tensione) <b>切（電源）</b> <b>关（电源）</b>
	Protective earth (ground) Schutzleiteranschluß Liaison à la terre Puesta a tierra de protección Collegamento di protezione a terra <b>保護アース（接地）</b> <b>保护接地</b>
	Earth (ground) Erde Terre Tierra Scarica a terra <b>アース（接地）</b> <b>接地</b>

[www.beckmancoulter.com](http://www.beckmancoulter.com)

